

**iDS-2CD7146G2/LM-IZ(H)S(Y)**  
**4MP DeepinViewX Moto Varifocal Dome Camera****DarkFighter 2.0****DeepinView X**

Hikvision has been dedicated to develop products with security since established.

Hikvision always follows security by design principle and has adopted many methods of security technologies into our product development lifecycle, including terminal security, data security, application security, network security, and privacy protection. In the meantime, the security technologies used by Hikvision are all in compliance with local applicable laws and safety regulations. These security measures could enhance product's cyber security protection capability and protect your devices as well as your data from malicious cyber attacks.

- High quality imaging with 4 MP resolution
- Excellent low-light performance via DarkFighter2.0 technology
- Clear imaging against strong back light due to 150 dB AWDR technology
- Efficient H.265+ compression technology to save bandwidth and storage
- 5 streams to meet a wide variety of applications
- Water and dust resistant (IP67), vandal proof (IK10) and corrosion resistant (NEMA 4X, optional)
- Built-in dual MIC and speaker
- Supports Guanlan large model algorithms, license plate recognition, vehicle attribute analysis, perimeter protection, AIOP with built-in PPE detection model
- Capable of loading trained large model algorithm packages from the AI training platform

## ▪ Function

### Perimeter Protection

With embedded deep learning based target detection and classification algorithms, the camera carries out the duty of perimeter protection, monitoring the actions of line crossing, intrusion, region entrance, and region exiting. The algorithms greatly filter out the mistaken alarm caused by the interference of leaves, lights, animal, flag, etc.

### Road Traffic and Vehicle Detection

With embedded deep learning based license plate capture and recognition algorithms, the camera alone can achieve plate capture and recognition. The algorithm enjoys the high recognition accuracy of common plates and complex-structured plates, which is a great step forward comparing to traditional algorithms. Blocklist and allowlist are available for plate categorization and separate alarm triggering.

## ▪ Specification

Camera	
Image Sensor	1/1.8" Progressive Scan CMOS
Max. Resolution	2688 × 1520
Min. Illumination	Color: 0.0005 Lux @ (F1.2, AGC ON), B/W: 0.0001 Lux @ (F1.2, AGC ON), B/W: 0 Lux with IR, 0 Lux with light
Shutter Time	1 s to 1/100,000 s
Day & Night	IR cut filter, Blue glass module (less ghost phenomenon)
Lens	
Focal Length & FOV	2.8 to 12 mm, horizontal FOV 112.5° to 47.7°, vertical FOV 58.2° to 26.7°, diagonal FOV 138.2° to 54.8° 8 to 32 mm, horizontal FOV 42.5° to 15.2°, vertical FOV 23.4° to 8.7°, diagonal FOV 49.7° to 17.3°
Focus	Auto, Semi-auto, Manual
Iris Type	P-iris
Aperture	2.8 to 12 mm: F1.4 to F2.1 8 to 32 mm: F1.7 to F1.7
DORI	
OODPCVS	<p>Wide:</p> <p>2.8 to 12 mm: Overview: 75.9 m, Outline: 37.9 m, Discern: 19.0 m, Perceive: 12.1 m, Characterize: 6.1 m, Validate: 3.0 m, Scrutinize: 1.0 m 8 to 32 mm: Overview: 187.9 m, Outline: 94.0 m, Discern: 47.0 m, Perceive: 30.1 m, Characterize: 15.0 m, Validate: 7.5 m, Scrutinize: 2.5 m</p> <p>Tele:</p> <p>2.8 to 12 mm: Overview: 160.3 m, Outline: 80.2 m, Discern: 40.1 m, Perceive: 25.7 m, Characterize: 12.8 m, Validate: 6.4 m, Scrutinize: 2.1 m 8 to 32 mm: Overview: 500.0 m, Outline: 250.0 m, Discern: 125.0 m, Perceive: 80.0 m, Characterize: 40.0 m, Validate: 20.0 m, Scrutinize: 6.7 m</p> <p>The OODPCVS values are calculated using pixel densities for different use cases as recommended by the IEC/EN 62676-4:2025 standard. IEC 62676-4:2025 describes the planning, design, installation, testing, commissioning, and maintaining of video surveillance systems (VSS) comprising image capture device(s), interconnection(s) and image handling device(s), for use in security applications within private or public spaces.</p>
Illuminator	
Supplement Light Type	IR
Supplement Light Range	2.8 to 12 mm: Monitoring: 40 m; 8 to 32 mm: Monitoring: 60 m
Smart Supplement Light	Yes
IR Wavelength	850 nm

AI Open Platform	
Model Specification	<p>1. Up to 3 models. Model type: detection model, classification model, mixed model (detection model and classification model).</p> <p>2. Supports video analysis (detection, classification, mixed, OCR, segmentation, comparison) and scheduled capture analysis (classification).</p> <p>(1) Detection: Region target exception status detection, line crossing target detection, line crossing target counting, region target number counting, full analysis rule, combined rule, area overlap ratio counting, area overlap ratio exception detection.</p> <p>(2) Classification: Region exception status detection, full analysis rule.</p> <p>(3) Mixed: Region target exception status detection, line crossing target detection, line crossing target counting, region target number counting, full analysis rule, combined rule; area overlap ratio counting, area overlap ratio exception detection.</p> <p>(4) Picture Comparison: Area status change detection.</p> <p>(5) OCR: OCR-triggered capture.</p> <p>(6) OVD: Region target exception status detection, line crossing target detection, line crossing target counting, region target number counting, full analysis rule, combined rule, area overlap ratio counting, area overlap ratio exception detection.</p> <p>3. Supports 4 model packages, each capable of detecting 16 target types and classifying 4 targets. The targets can be classified as 64 types. The device runs only 1 model at the same time.</p> <p>4. Built-in models for PPE detection (hard hat and reflective clothing).</p>
Video	
Main Stream	50 Hz:25 fps(2688 × 1520,2560 × 1440,1920 × 1080,1280 × 720) 60 Hz:30 fps(2688 × 1520,2560 × 1440,1920 × 1080,1280 × 720)
Sub-Stream	50 Hz: 25 fps (704 × 576, 640 × 480) 60 Hz: 30 fps (704 × 480, 640 × 480)
Third Stream	50 Hz:25 fps(1920 × 1080,1280 × 720,704 × 576,640 × 480) 60 Hz:30 fps(1920 × 1080,1280 × 720,704 × 480,640 × 480)
Video Compression	Main stream: H.265+/H.265/H.264+/H.264, Sub-stream: H.265/H.264/MJPEG, Third stream: H.265/H.264
Video Bit Rate	32 Kbps to 8 Mbps
H.264 Type	Baseline Profile,Main Profile,High Profile
H.265 Type	Main Profile
Bit Rate Control	CBR,VBR
Scalable Video Coding (SVC)	H.264 and H.265 encoding
Region of Interest (ROI)	4 fixed regions for each stream
Target Cropping	No
e-PTZ	Support Patrol and Auto Tracking settings
Audio	
Audio Type	Mono sound
Audio Compression	G.711/G.722.1/G.726/MP2L2/PCM/MP3/AAC-LC
Audio Bit Rate	64 Kbps (G.711ulaw/G.711alaw)/16 Kbps (G.722.1)/16 Kbps (G.726)/32 to 192 Kbps (MP2L2)/8 to 320 Kbps (MP3)/16 to 64 Kbps (AAC-LC)
Audio Sampling Rate	8 kHz/16 kHz/32 kHz/48 kHz
Environment Noise Filtering	Yes

<b>Network</b>	
Protocols	IPv6,RTP,ICMP,PPPoE,DNS,WebSocket,TCP/IP,SSL/TLS,HTTPS,RTSP,IGMP,SNMP,NTP,S MTP,WebSockets,SFTP,UPnP,DHCP,802.1X,IPv4,FTP,UDP,QoS,RTCP,HTTP,DDNS
Simultaneous Live View	Up to 20 channels
API	ISAPI,SDK,ISUP,OTAP,ONVIF (Profile S, Profile G, Profile T, Profile M)
User/Host	Up to 32 users 3 user levels: administrator, operator, and user
Security	Password protection, complicated password, HTTPS encryption, 802.1X authentication (EAP-TLS, EAP-LEAP, EAP-MD5), watermark, IP address filter, basic and digest authentication for HTTP/HTTPS, WSSE and digest authentication for Open Network Video Interface, RTP/RTSP OVER HTTPS, Control Timeout Settings, Security Audit Log, TLS 1.2, TLS 1.3, TPM 2.0 (FIPS 140-2 level 2, CC EAL4+), AES128/256
Network Storage	NAS (NFS, SMB/CIFS),Auto Network Replenishment (ANR), Together with high-end Hikvision memory card, memory card encryption and health detection are supported.
Client	iVMS-4200,Hik-Connect,Hik-Central
Web Browser	Plug-in required live view: IE 10, IE 11, Plug-in free live view: Chrome 57.0+, Firefox 52.0+, Edge 89+, Safari 11+, Local service: Chrome 57.0+, Firefox 52.0+, Edge 89+
<b>Image</b>	
Image Parameters Switch	Yes
Image Settings	Rotate mode,saturation,brightness,contrast,sharpness,white balance,AGC,adjustable by client software or web browser
Day/Night Switch	Day,Night,Auto,Schedule,Alarm Trigger
Wide Dynamic Range (WDR)	150 dB
Image Enhancement	BLC,HLC,3D DNR,Distortion Correction,Defog
Privacy Mask	8 programmable polygon privacy masks
SNR	≥ 52 dB
Picture Overlay	LOGO picture can be overlaid on video with 128 × 128 24 bit bmp format.
Image Stabilization	EIS
<b>Interface</b>	
Video Output	1 Vp-p Composite Output (75 Ω/CVBS) (Only for debugging)
Ethernet Interface	1 RJ45 10 M/100 M/1000 M self-adaptive Ethernet port
On-Board Storage	Built-in memory card slot, support microSD/microSDHC/microSDXC card, up to 1 TB
Alarm	2 inputs, 2 outputs (max. 24 VDC/24 VAC, 1 A)
Built-in Microphone	2 built-in microphones
Audio	1 input (line in), 3.5 mm connector, three-contact, max. input amplitude: 3.3 Vpp, input impedance: 4.7 KΩ, interface type: non-equilibrium, 1 output (line out), 3.5 mm connector, three-contact, max. output amplitude: 3.3 Vpp, output impedance: 100 Ω, interface type: non-equilibrium, mono sound
Built-in Speaker	1 built-in speaker,Max. power consumption: 1.5 W
RS-485	1 RS-485 (Half duplex, HIKVISION, Pelco-P, Pelco-D, self-adaptive)
Reset Key	Yes
Power Output	12VDC,max.100mA,External extension cord less than 10 meters.

Event	
Basic Event	Motion detection (support alarm triggering by specified target types (human and vehicle)),video tampering alarm,video quality diagnosis,exception (network disconnected, IP address conflict, illegal login, abnormal restart, HDD full, HDD error),vibration detection
Smart Event	scene change detection,audio exception detection,defocus detection, unattended baggage detection,loitering detection,object removal detection,people gathering detection,fast moving detection,parking detection
Linkage	Upload to FTP/NAS/memory card,notify surveillance center,send email,trigger alarm output,trigger recording,trigger capture,audible warning
Deep Learning Function	
Perimeter Protection	Line crossing, intrusion, region entrance, region exiting Support alarm triggering by specified target types (human and vehicle) Support combined event alarm triggering
Metadata	Intrusion detection,line crossing detection,region entrance detection,region exiting detection
Road Traffic and Vehicle Detection	Accuracy (under recommended installation and lighting conditions) Capture rate > 98%  Vehicle moving direction recognition accuracy > 96%  Mistaken capture rate < 2% (entrance/exit), < 5% (checkpoint)  Blocklist and allowlist: up to 10000 records Captures vehicle that has no license plate Support license plate recognition of motorcycles (only in checkpoint scenario) Support vehicle attribute detection, including vehicle type, color, brand, etc. (City Street mode is recommended.
General	
Power	three-core terminal block, 12 VDC $\pm$ 20%, 1.51 A, max. 18.1 W, 24 VAC $\pm$ 20%, 1.3 A, max. 17.9 W, PoE: IEEE 802.3at, Type 2, Class 4, 42.5 V to 57 V, 0.39 A to 0.29 A, max. 18.7 W
Material	Aluminum alloy body
Dimension	$\varnothing$ 144.3 mm $\times$ 114.1 mm ( $\varnothing$ 5.7" $\times$ 4.5")
Package Dimension	244 mm $\times$ 174 mm $\times$ 173 mm (9.6" $\times$ 6.9" $\times$ 6.8")
Weight	Approx. 1100 g (2.43 lb.)
With Package Weight	Approx. 1482 g (3.27 lb.)
Storage Conditions	-40 °C to 65 °C (-40 °F to 149 °F). Humidity 95% or less (non-condensing)
Startup and Operating Conditions	With -H: -40 °C to 65 °C (-40 °F to 149 °F). Humidity 95% or less (non-condensing), Without -H: -30 °C to 65 °C (-22 °F to 149 °F). Humidity 95% or less (non-condensing)
Language	33 languages: English, Russian, Estonian, Bulgarian, Hungarian, Greek, German, Italian, Czech, Slovak, French, Polish, Dutch, Portuguese, Spanish, Romanian, Danish, Swedish, Norwegian, Finnish, Croatian, Slovenian, Serbian, Turkish, Korean, Traditional Chinese, Thai, Vietnamese, Japanese, Latvian, Lithuanian, Portuguese (Brazil), Ukrainian
General Function	Heartbeat,anti-banding,one-key reset,mirror,password protection,flash log
Heater	Yes

Device Management	Supports adding alarm box (DS-FM2466) in the LAN to expand 6 additional input and 6 output alarm interfaces
Integrated Connector Panel	No
<b>Approval</b>	
EMC	CE-EMC: EN 55032:2015+A1:2020, EN 50130-4:2011+A1:2014, EN IEC 61000-3-2:2019+A1:2021, EN 61000-3-3:2013+A1:2019+A2:2021, RCM: AS/NZS CISPR 32: 2015
Safety	CB: IEC 62368-1: 2014+A11, CE-LVD: EN 62368-1: 2014/A11: 2017, LOA: IEC/EN 60950-1
Environment	CE-RoHS: 2011/65/EU, WEEE: 2012/19/EU, Reach: Regulation (EC) No 1907/2006
Protection	IP67: IEC 60529-2013, IK10: IEC 62262:2002
Anti-Corrosion Protection	-Y: NEMA 4X (NEMA 250-2018)
Other	PVC FREE

## ▪ Typical Application

Hikvision products are classified into three levels according to their anti-corrosion performance. Refer to the following description to choose for your using environment.

With -Y model: This model has MODERATE PROTECTION.

Without -Y model: This model has NO SPECIFIC PROTECTION.

Level	Description
Top-level protection	Hikvision products at this level are equipped for use in areas where professional anti-corrosion protection is a must. Typical application scenarios include coastlines, docks, chemical plants, and more.
Moderate protection	Hikvision products at this level are equipped for use in areas with moderate anti-corrosion demands. Typical application scenarios include coastal areas about 2 kilometers (1.24 miles) away from coastlines, as well as areas affected by acid rain.
No specific protection	Hikvision products at this level are equipped for use in areas where no specific anti-corrosion protection is needed.

## ▪ Available Model

iDS-2CD7146G2/LM-IZHSY(8-32mm)

iDS-2CD7146G2/LM-IZHSY(2.8-12mm)

iDS-2CD7146G2/LM-IZS(8-32mm)

iDS-2CD7146G2/LM-IZS(2.8-12mm)

## ▪ Dimension

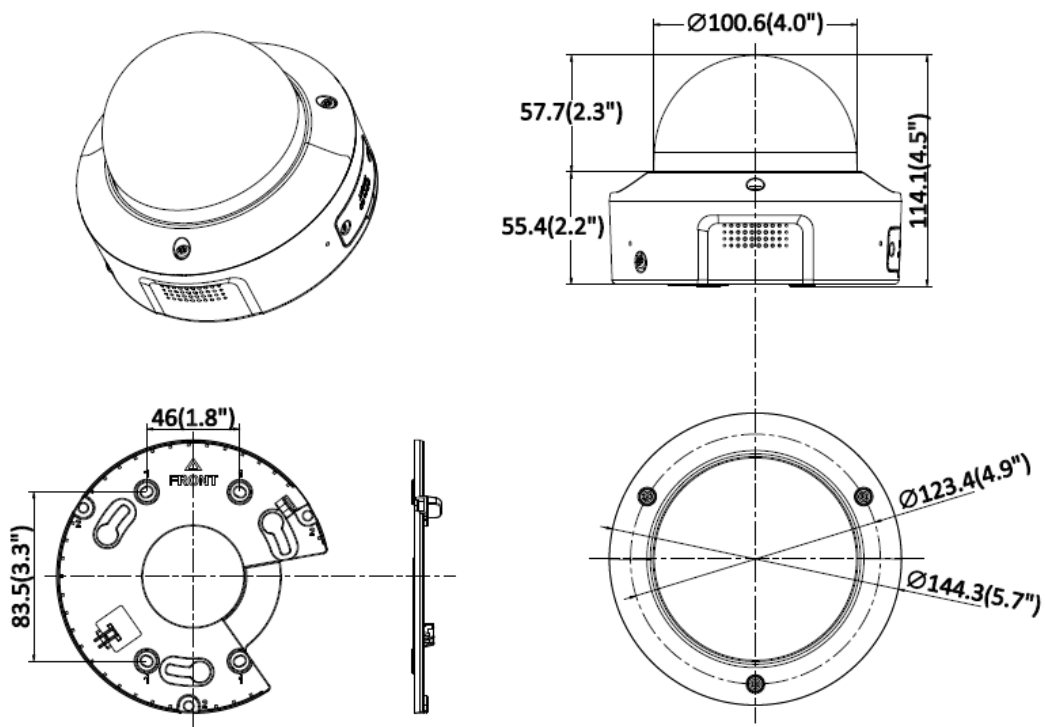





Unit:mm (inch)

Camera Mounting Hole (mm)	Camera Mounting Hole (inch)
Double Gang(4* $\phi$ 4.5)	Double Gang(4* $\phi$ 0.2")



▪ Accessory

▪ Optional

DS-2200ZJ-WA-140	DS-2280ZJ-WA140	DS-1475ZJ-SUS	DS-1227ZJ-DM32	DS-2200ZJ-WAJ-140
				
DS-1476ZJ-SUS	DS-2210ZJ-WA-140	DS-1271ZJ-140-DM 45	DS-1273ZJ-160-AK S	DS-4220ZJ-WC

				
<b>DS-1281ZJ-DM23</b>	<b>DS-1475ZJ-Y</b>	<b>DS-1476ZJ-Y</b>		
				

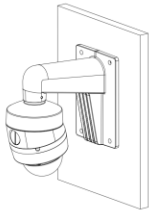
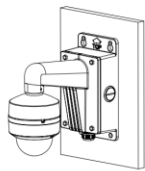
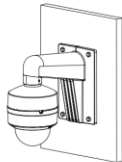
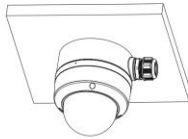
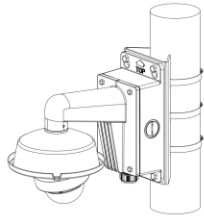
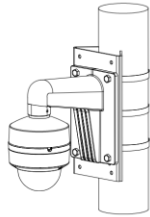
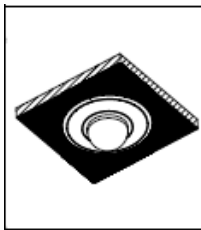
**Installation Methods**

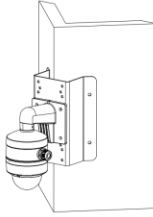
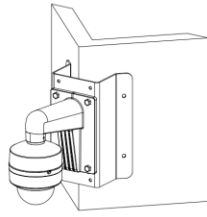
<b>Wall Mounting</b> DS-2200ZJ-WA-140+D S-1281ZJ-DM23	<b>Wall Mounting</b> DS-2200ZJ-WAJ-140	<b>Wall Mounting</b> DS-1273ZJ-160-AKS	<b>Junction Box</b> DS-2280ZJ-WA140	<b>Vertical Pole Mounting</b> DS-1475ZJ-SUS+DS-12 81ZJ-DM23+DS-1253Z J-L+DS-2200ZJ-WAJ-1 40
				
<b>Vertical Pole Mounting</b> DS-1475ZJ-Y+DS-1273 ZJ-160-AKS	<b>In-Ceiling Mounting</b> DS-1227ZJ-DM32	<b>In-Ceiling Mounting</b> DS-4220ZJ-WC	<b>Corner Mounting</b> DS-1476ZJ-SUS+DS-22 80ZJ-WA140+DS-2200 ZJ-WA-140	<b>Corner Mounting</b> DS-1476ZJ-Y+DS-1273 ZJ-160-AKS
				
<b>Pendant Mounting</b> DS-2210ZJ-WA-140	<b>Pendant Mounting</b> DS-1271ZJ-140-DM45 +DS-1281ZJ-DM23	<b>Inclined Ceiling Mounting</b> DS-1281ZJ-DM23		

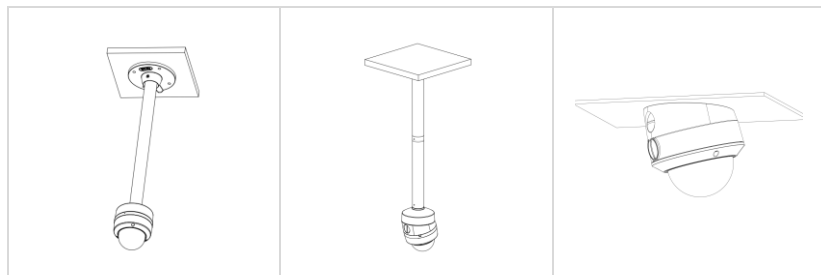

# See Far, Go Further



[www.hikvision.com](http://www.hikvision.com)  
[support@hikvision.com](mailto:support@hikvision.com)

