

DS-2DP7D425IXG1-LEF/416
4MPx4 360° Panoramic & 4MP 25x PTZ Camera

Hikvision has been dedicated to develop products with security since established. Hikvision always follows security by design principle and has adopted many methods of security technologies into our product development lifecycle, including terminal security, data security, application security, network security, and privacy protection. In the meantime, the security technologies used by Hikvision are all in compliance with local applicable laws and safety regulations. These security measures could enhance product's cyber security defense capability and protect your devices as well as your data from malicious cyber attacks.

- Captures a large area and great details at the same time
- 24/7 colorful imaging and excellent low-light performance
- Motorized pan, tilt and rotation in 4 panoramic lenses for flexible adjustment
- 4 adjustable lenses in one camera cover up to 360° field of view, ensuring no blind area monitoring and the monitoring tilt angle can be adjusted
- Clear imaging against strong back light due to 120 dB(panorama) and 150 dB(PTZ) WDR technology
- High quality imaging with 4 MP resolution for both panoramic channel and PTZ channel
- Secures an expansive area with 25x optical zoom and 16x digital zoom
- Supports deep learning functions
- Water and dust resistant (IP67) and vandal resistant (IK10)

▪ Specification

Camera	
Image Sensor	[Panoramic channel] 1/1.8" Progressive Scan CMOS, [PTZ channel] 1/1.8" Progressive Scan CMOS
Max. Resolution	[Panoramic channel] 2688 × 1520, [PTZ channel] 2688 × 1520
Min. Illumination	Color: 0.0005 Lux @ (F1.0, AGC ON), [PTZ channel] Color: 0.0005 Lux @ (F1.2, AGC ON), B/W: 0.0001 Lux @ (F1.2, AGC ON), 0 lux with IR
Shutter Speed	1/30 s to 1/30000 s
Day & Night	IR cut filter
Zoom	25 × optical, 16 × digital
Slow Shutter	Yes
Lens	
Focal Length	[Panoramic channel] 2.8 mm, [PTZ channel] 5.9mm to 147.5 mm
FOV	[Panoramic channel] horizontal field of view: 106.3°, vertical field of view: 56.2°, diagonal field of view: 131.3°, [PTZ channel] horizontal field of view: 57.6° to 3.3°, vertical field of view: 32.3° to 1.8°, diagonal field of view: 67.1° to 2.3°
Focus	Auto, semi-auto, manual, rapid focus
Aperture	[Panoramic channel] Max. F1.0, [PTZ channel] Max. F1.6
Zoom Speed	Approx. 4.5 s
Illuminator	
Supplement Light Type	IR
Supplement Light Range	300 m
PTZ	
Movement Range (Pan)	[PTZ channel] 0° to 360°, [Panoramic channel] 0° to 175°
Movement Range (Tilt)	[Panoramic channel] 9° to 65°, [PTZ channel] -20° to 90°
Pan Speed	[PTZ channel] pan speed: configurable from 0.1° to 700°/s, preset speed: 700°/s
Movement Range (Rotate)	[Panoramic channel] -90° to 90°
Tilt Speed	[PTZ channel] tilt speed: configurable from 0.1° to 500°/s, preset speed 500°/s
Proportional Pan	[Panoramic channel] No, [PTZ channel] Yes
Presets	300
Preset Freezing	Yes
Patrol Scan	8 patrols, up to 32 presets for each patrol
Pattern Scan	4 pattern scans, record time over 10 minutes for each scan
Park Action	Preset, pattern scan, patrol scan, auto scan, tilt scan, random scan, frame scan, panorama scan
3D Positioning	Yes
PTZ Status Display	Yes
Scheduled Task	Preset, pattern scan, patrol scan, auto scan, tilt scan, random scan, frame scan, panorama scan, dome reboot, dome adjust, aux output
Power-off Memory	Yes

Video	
Main Stream	[PTZ channel] Channel 1: 50 Hz: 50 fps (2688 × 1520, 2560 × 1440), 100 fps (1920 × 1080, 1280 × 960, 1280 × 720) 60 Hz: 60 fps (2688 × 1520, 2560 × 1440), 120 fps (1920 × 1080, 1280 × 960, 1280 × 720) [Panoramic channel] Channel 2,3,4,5: 50 Hz: 50 fps (2688 × 1520, 2560 × 1440, 1920 × 1080, 1280 × 960) 60 Hz: 60 fps (2688 × 1520, 2560 × 1440, 1920 × 1080, 1280 × 960)
Sub-Stream	50 Hz: 25 fps (704 × 576, 640 × 480, 352 × 288) 60 Hz: 30 fps (704 × 480, 640 × 480, 352 × 240)
Third Stream	50 Hz: 25 fps (1920 × 1080, 1280 × 960, 1280 × 720, 704 × 576, 640 × 480, 352 × 288) 60 Hz: 30 fps (1920 × 1080, 1280 × 960, 1280 × 720, 704 × 480, 640 × 480, 352 × 240)
Video Compression	Main stream: H.265+/H.265/H.264+/H.264, Sub-stream: H.265/H.264/MJPEG, Third stream: H.265/H.264/MJPEG
Video Bit Rate	32 Kbps to 16 Mbps
H.264 Type	Baseline profile, Main profile, High profile
H.265 Type	Main profile
Region of Interest (ROI)	8 fixed regions for each stream
Audio	
Audio Compression	G.711, G.722.1, G.726, MP2L2, PCM
Audio Bit Rate	32 to 192 Kbps (MP2L2)
Audio Sampling Rate	MP2L2: 16 to 48 kHz, PCM: 8 to 48 kHz
Environment Noise Filtering	Yes
Network	
Protocols	IPv4/IPv6, HTTP, HTTPS, 802.1X, QoS, SMTP, UPnP, SNMP, DNS, DDNS, NTP, RTSP, RTCP, RTP, TCP/IP, UDP, IGMP, ICMP, DHCP, PPPoE, Bonjour, FTP
Simultaneous Live View	Up to 20 channels
API	ONVIF (Profile S, Profile G, Profile T), ONVIF (Profile M), ISAPI, SDK, ISUP, EZVIZ
User/Host	Up to 32 users. 3 user levels: administrator, operator, and user
Security	Password protection, complicated password, IP address filter, HTTPS encryption, 802.1X authentication (EAP-TLS, EAP-LEAP, EAP-MD5), host authentication (MAC address), watermark
Network Storage	NAS (NFS, SMB/CIFS), auto network replenishment (ANR)
Client	iVMS-4200, HikCentral Pro, Hik-Connect
Web Browser	IE 10+, Chrome 57+, Firefox 52+, Safari 12+
Image	
Image Parameters Switch	Yes
Image Settings	Saturation, brightness, contrast, sharpness, gain, and white balance adjustable by client software or web browser
Day/Night Switch	Day, night, auto, schedule
Wide Dynamic Range (WDR)	[Panoramic channel] 120 dB, [PTZ channel] 150 dB
SNR	≥ 52 dB
Defog	Digital defog
Image Stabilization	EIS (Built-in gyroscope to improve EIS performance)

Image Enhancement	HLC,3D DNR
Privacy Mask	mask color or mosaic configurable,24 programmable polygon privacy masks
Regional Focus	Yes
Regional Exposure	Yes
Supplement Detection	
Satellite Positioning	No
Gyroscope	Yes
Compass	No
Interface	
Ethernet Interface	1 RJ45 10M/100M/1000MM self-adaptive Ethernet port
Audio	1 input (line in), two-core terminal, max. input amplitude: 3.3 vpp, input impedance: 4.7 K Ω ,1 output (line out), two-core terminal, max. output amplitude: 3.3 vpp, output impedance: 4.7K Ω
Alarm	7 input(s), 2 output(s)
RS-485	1 RS-485 (Half duplex, HIKVISION, Pelco-P, Pelco-D, self-adaptive)
Reset	Yes
On-board Storage	Built-in memory card slot, support microSD/microSDHC/microSDXC card, up to 1 TB .
Built-in Microphone	1 built-in microphone,picking up sounds in the radius up to 5 meters
Built-in Speaker	1 built-in speaker, with effective distance reaching max. 8 meters
Fiber Optical	1 FC interface, built-in fiber module, 1000M, TX1310/RX1550 nm wavelength, single module fiber, up to 20 km transmission distance
Event	
Basic Event	Motion detection,video tampering alarm,exception,alarm input and output
Linkage	Upload to FTP/NAS/memory card,notify surveillance center,send email,trigger alarm output,trigger recording,trigger capture
Smart Tracking	Manual tracking,auto-tracking,panorama tracking
Smart Linkage	3D positioning, manual tracking, auto tracking, linked tracking capture
Deep Learning Function	
Multi-Target-Type Detection	[PTZ channel] Supports simultaneous detection and capture of human body and face
Perimeter Protection	Line crossing detection;intrusion detection;region entrance detection;region exiting detection
Linkage and Tracking	
Smart Tracking	Manual tracking, auto-tracking 3.0
Smart Linkage	Manual tracking, auto tracking, tracking takeover, linked tracking capture
Object Tracking	Support person arming. When the device detects the armed face or human body in the monitoring scene, it triggers alarms, and tracks and captures the target. During the tracking, the target location and other related information are uploaded.Support vehicle arming. When the device detects the armed vehicles in the monitoring scene, it triggers alarms, and tracks and captures the target. During the tracking, the target location and other related information are uploaded.
General	
Power	36 VDC \pm 25%, max. 100 W (Max. 80 W, including max. 6.8 W for IR) PoE 802.3bt, type4, class8, max. 90 W (Max. 75 W, including max. 6.8 W for IR)
Dimension	\varnothing 402.37 mm \times 363.22 mm (\varnothing 15.84" \times 14.3")
Weight	Weight Approx. 9.67 kg (21.32 lb.) With Package Weight Approx. 12.69 kg (27.98 lb.)
Material	ADC12

Operating Condition	-40 °C to 70 °C (-40 °F to 158 °F). Humidity 95% or less (non-condensing),For speaker: -30 °C to 55°C (-22°F to 122°F)
General Function	mirror,password protection
Wiper	No
Demist	Yes
Language	33 languages: English, Russian, Estonian, Bulgarian, Hungarian, Greek, German, Italian, Czech, Slovak, French, Polish, Dutch, Portuguese, Spanish, Romanian, Danish, Swedish, Norwegian, Finnish, Croatian, Slovenian, Serbian, Turkish, Korean, Traditional Chinese, Thai, Vietnamese, Japanese, Latvian, Lithuanian, Portuguese (Brazil), Ukrainian
Approval	
EMC	CE-EMC (EN 55032:2015, EN 61000-3-2: 2019, EN 61000-3-3: 2013 + A1: 2019, EN 50130-4: 2011 + A1: 2014)
Safety	CE-LVD (EN 62368-1: 2014/A11: 2017)
Environment	CE-RoHS (2011/65/EU),WEEE (2012/19/EU),Reach (Regulation (EC) No 1907/2006)
Protection	IP67 (IEC 60529-2013),TVS 6000 V lightning protection, surge protection and voltage transient protection
Anti-Corrosion Protection	NO

▪ DORI

The DORI (detect, observe, recognize, identify) distance gives the general idea of the camera ability to distinguish persons or objects within its field of view. It is calculated based on the camera sensor specification and the criteria given by EN 62676-4: 2015.

DORI	Detect	Observe	Recognize	Identify
Definition	25 px/m	63 px/m	125 px/m	250 px/m
[PTZ channel] Distance (Tele)	2034.5 m (6674.87 ft.)	807.3 m (2648.62 ft)	406.9 m (1334.97 ft.)	203.4 m (667.32 ft.)
[Panoramic channel] Distance	38.6 m (126.64 ft.)	15.3 m (50.20 ft.)	7.7 m (25.26 ft.)	3.9 m (12.80 ft.)

▪ Typical Application

Hikvision products are classified into three levels according to their anti-corrosion performance. Refer to the following description to choose for your using environment.

DS-2DP7D436IXG1-LEF and has NO SPECIFIC PROTECTION.

DS-2DP7D436IXG1-LEFY has MODERATE PROTECTION.

Level	Description
Top-level protection	Hikvision products at this level are equipped for use in areas where professional anti-corrosion protection is a must. Typical application scenarios include coastlines, docks, chemical plants, and more.
Moderate protection	Hikvision products at this level are equipped for use in areas with moderate anti-corrosion demands. Typical application scenarios include coastal areas about 2 kilometers (1.24 miles) away from coastlines, as well as areas affected by acid rain.
No specific protection	Hikvision products at this level are equipped for use in areas where no specific anti-corrosion protection is needed.

▪ Dimension

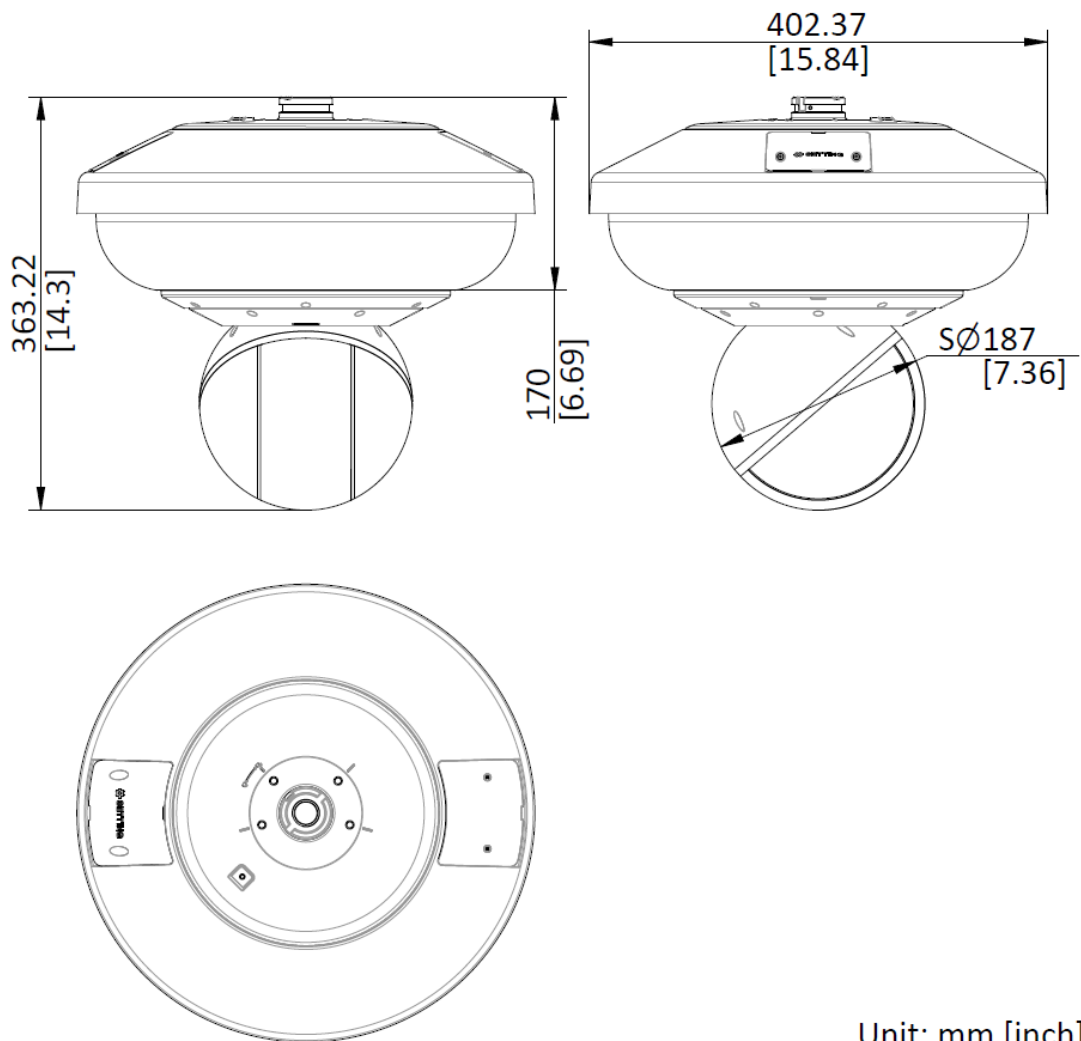

Unit: mm [inch]

SCALE	1:1
-------	-----





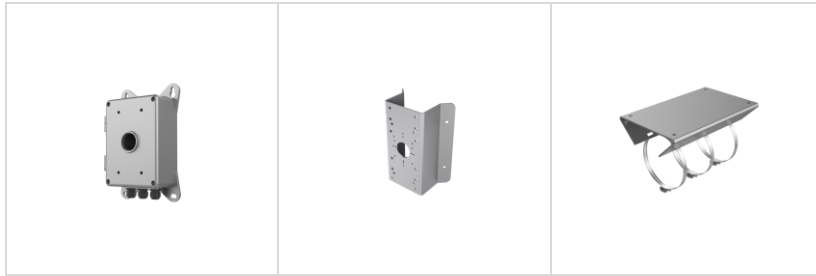

▪ Accessory

▪ Optional

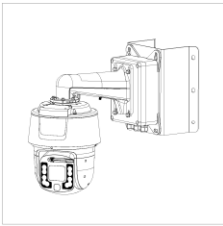
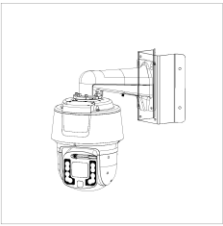
DS-4660ZJ-PC	DS-4612ZJ-PA	DS-1684ZJ-P	DS-1673ZJ-P	DS-4603ZJ-PA
DS-1674ZJ-P	DS-1276ZJ-P	DS-4650ZJ-PC		

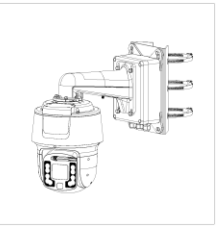

▪ **Installation Methods**

<p>Corner Mounting DS-4660ZJ-PC+DS-4603ZJ-PA+DS-1674ZJ-P</p>	<p>Corner Mounting DS-1276ZJ-P+DS-4603ZJ-PA</p>	<p>Pendant Mounting DS-4612ZJ-PA</p>	<p>Vertical Pole Mounting DS-1684ZJ-P+DS-4603ZJ-PA</p>	<p>Vertical Pole Mounting DS-4650ZJ-PC+DS-4603ZJ-PA+DS-1674ZJ-P</p>
				
<p>Horizontal Pole Mounting DS-1673ZJ-P+DS-4612ZJ-PA</p>	<p>Wall Mounting DS-4603ZJ-PA</p>	<p>Junction Box DS-1674ZJ-P+DS-4603ZJ-PA</p>		
				

See Far, Go Further



www.hikvision.com
support@hikvision.com

