

DS-2CD1143G0-I(T1)
4MP Fixed Dome Network Camera



- High quality imaging with 4 MP resolution
- Efficient H.265+ compression technology
- Clear imaging even with strong back lighting due to 120 dB WDR
- Water and dust resistant (IP67) and vandal resistant (IK10)
- EXIR 2.0: advanced infrared technology with long IR range

▪ Specification

Camera	
Image Sensor	1/3" progressive scan CMOS
Max. Resolution	2560 × 1440
Min. Illumination	Color: 0.01 Lux @(F2.0, AGC ON), B/W: 0 Lux with IR
Shutter Time	1/3 s to 1/100,000 s
Day & Night	IR cut filter
Angle Adjustment	Pan: 0° to 355°, tilt: 0° to 75°
Lens	
Focal Length & FOV	2.8 mm, horizontal FOV 98.0°, vertical FOV 53.1°, diagonal FOV 114.7° 4 mm, horizontal FOV 78.7°, vertical FOV 43.1°, diagonal FOV 92.3°
Lens Mount	M12
Focus	Fixed
Aperture	F2.0
Lens Type	Fixed focal lens, 2.8 and 4 mm optional
Iris Type	Fixed
Illuminator	
Supplement Light Type	IR
Supplement Light Range	Up to 30 m
IR Wavelength	850 nm
Smart Supplement Light	Yes
Video	
Main Stream	50 Hz: 20 fps (2560 × 1440) 25 fps (1920 × 1080, 1280 × 720) 60 Hz: 20 fps (2560 × 1440) 30 fps (1920 × 1080, 1280 × 720)
Sub-Stream	50 Hz: 25 fps (640 × 480, 640 × 360) 60 Hz: 30 fps (640 × 480, 640 × 360)
Video Compression	Main stream: H.265/H.264/H.264+/H.265+ Sub-stream: H.265/H.264/MJPEG
Video Bit Rate	32 Kbps to 8 Mbps
H.264 Type	Baseline Profile/Main Profile/High Profile
H.265 Type	Main Profile
Region of Interest (ROI)	1 fixed region for main stream
Network	
Protocols	TCP/IP, ICMP, HTTP, HTTPS, FTP, DHCP, DNS, DDNS, RTP, RTSP, RTCP, NTP, UPnP, SMTP, SNMP, IGMP, QoS, IPv6, Bonjour, IPv4, UDP, SSL/TLS
Simultaneous Live View	Up to 6 channels
API	Open Network Video Interface, ISAPI
User/Host	Up to 32 users. 3 levels: administrator, operator and user
Client	iVMS-4200, Hik-Connect
Web Browser	Plug-in required live view: IE 10, IE 11, Plug-in free live view: Chrome 57.0+, Firefox 52.0+, Edge 89+ Local service: Chrome 57.0+, Firefox 52.0+, Edge 89+

Image	
Image Settings	Saturation, brightness, contrast, sharpness, AGC, white balance adjustable by client software or web browser
Day/Night Switch	Auto, Schedule, Day, Night
Wide Dynamic Range (WDR)	120 dB
Image Enhancement	BLC, 3D DNR
Interface	
Ethernet Interface	1 RJ45 10 M/100 M self-adaptive Ethernet port
Event	
Basic Event	Motion detection, video tampering alarm, exception
Linkage	Upload to FTP, notify surveillance center, send email
General	
Power	12 VDC \pm 25%, 0.58 A, max. 7 W, \varnothing 5.5 mm coaxial power plug PoE: IEEE 802.3af, Class 3, 36 V to 57 V, 0.24 A to 0.15 A, max. 8.5 W
Material	Base: metal, cover: plastic
Dimension	\varnothing 111 mm \times 82.4 mm (\varnothing 4.4" \times 3.2")
Package Dimension	134 mm \times 134 mm \times 108 mm (5.3" \times 5.3" \times 4.3")
Weight	Approx. 360 g (0.8 lb.)
With Package Weight	Approx. 560 g (1.2 lb.)
Storage Conditions	-30 °C to 60 °C (-22 °F to 140 °F). Humidity: 95% or less (non-condensing)
Startup and Operating Conditions	-30 °C to 60 °C (-22 °F to 140 °F). Humidity: 95% or less (non-condensing)
Language	English, Ukrainian
General Function	Anti-banding, heartbeat, mirror, password protection, privacy mask, watermark, IP address filter
Approval	
EMC	FCC SDoC (47 CFR Part 15, Subpart B); CE-EMC (EN 55032:2015, EN 61000-3-2:2014, EN 61000-3-3:2013, EN 50130-4:2011+A1:2014); RCM (AS/NZS CISPR 32:2015); IC VoC (ICES-003: Issue 6, 2016); KC (KN 32:2015, KN 35:2015)
Safety	UL (UL 60950-1); CB (IEC 60950-1:2005 + Am 1:2009 + Am 2:2013, IEC 62368-1:2014); CE-LVD (EN 60950-1:2005 + Am 1:2009 + Am 2:2013, IEC 62368-1:2014); BIS (IS 13252(Part 1):2010+A1:2013+A2:2015)
Environment	CE-RoHS (2011/65/EU); WEEE (2012/19/EU); Reach (Regulation (EC) No 1907/2006)
Protection	IP67 (IEC 60529-2013), IK10 (IEC 62262:2002)

▪ Dimension

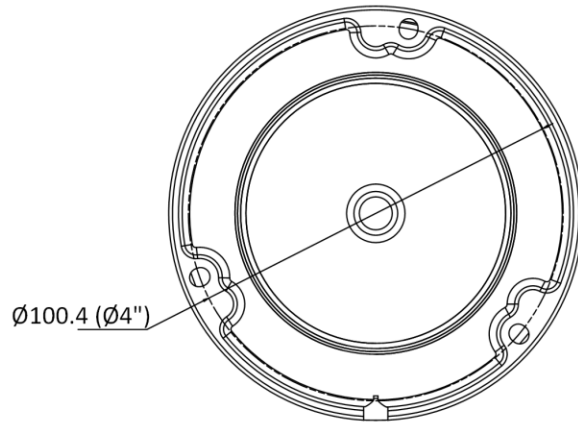
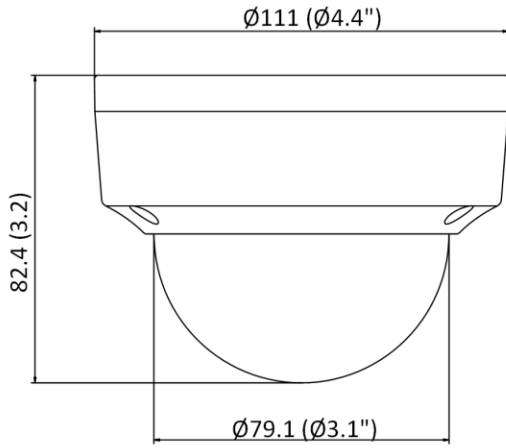







Unit: mm (inch)

▪ **Accessory**

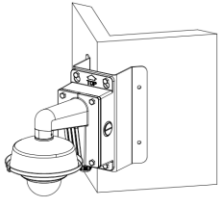
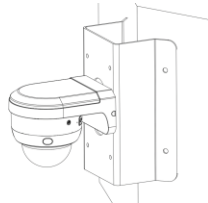
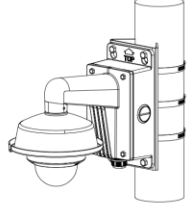
▪ **Optional**

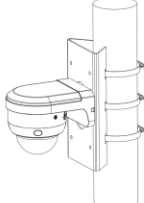
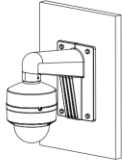
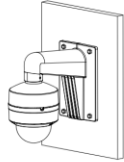
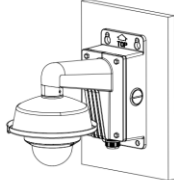
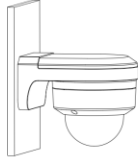
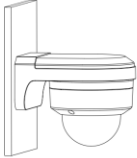
DS-1276ZJ-SUS	DS-1275ZJ-SUS	DS-1476ZJ-SUS	DS-1258ZJ	DS-1275ZJ-S-SUS
DS-1272ZJ-110	DS-1475ZJ-SUS	DS-1259ZJ	DS-1280ZJ-DM18	DS-1272ZJ-110B
DS-220AZJ-145-WA	DS-1271ZJ-110	DS-220AZJ-130-WA	DS-1250ZJ	

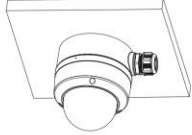
▪ **Installation Methods**

<p>Corner Mounting DS-1276ZJ-SUS+DS-1272ZJ-110B+DS-1253ZJ-M</p>	<p>Corner Mounting DS-1476ZJ-SUS+DS-220AZJ-130-WA</p>	<p>Vertical Pole Mounting DS-1275ZJ-SUS+DS-1272ZJ-110B+DS-1253ZJ-M</p>	<p>Vertical Pole Mounting DS-1275ZJ-S-SUS+DS-220AZJ-130-WA</p>	<p>Vertical Pole Mounting DS-1475ZJ-SUS+DS-220AZJ-145-WA</p>
				
<p>Wall Mounting DS-1258ZJ</p>	<p>Wall Mounting DS-1272ZJ-110</p>	<p>Wall Mounting DS-1272ZJ-110B+DS-1253ZJ-M</p>	<p>Wall Mounting DS-220AZJ-145-WA</p>	<p>Wall Mounting DS-220AZJ-130-WA</p>
				
<p>Inclined Ceiling Mounting DS-1259ZJ</p>	<p>Junction Box DS-1280ZJ-DM18</p>	<p>Pendant Mounting DS-1271ZJ-110</p>	<p>Others DS-1250ZJ</p>	
				

See Far, Go Further



www.hikvision.com
support@hikvision.com

