

DS-2CD2146G2-I(SU)
4 MP AcuSense Fixed Dome Network Camera

Empowered by deep learning algorithms, Hikvision AcuSense technology brings human and vehicle targets classification alarms to front- and back-end devices. The system focuses on human and vehicle targets, vastly improving alarm efficiency and effectiveness.

- High quality imaging with 4 MP resolution
- Excellent low-light performance with powered-by-DarkFighter technology
- Clear imaging against strong backlight due to 120 dB true WDR technology
- Efficient H.265+ compression technology
- Focus on human and vehicle targets classification based on deep learning
- Built-in microphone for real-time audio security(-SU)
- Water and dust resistant (IP67) and vandal-resistant (IK10)

▪ Specification

| Camera | |
|-----------------------------|--|
| Max. Resolution | 2688 × 1520 |
| Min. Illumination | Color: 0.003 Lux @ (F1.4, AGC ON), B/W: 0 Lux with IR |
| Shutter Time | 1/3 s to 1/100,000 s |
| Day & Night | IR cut filter |
| Image Sensor | 1/3" Progressive Scan CMOS |
| Angle Adjustment | Pan: 0° to 355°, tilt: 0° to 75°, rotate: 0° to 355° |
| Lens | |
| Aperture | F1.4 |
| Lens Type | Fixed focal lens, 2.8, 4, and 6 mm optional |
| Focal Length & FOV | 2.8 mm, horizontal FOV 103°, vertical FOV 55°, diagonal FOV 123° 4 mm, horizontal FOV 83°, vertical FOV 45°, diagonal FOV 98° 6 mm, horizontal FOV 53°, vertical FOV 28°, diagonal FOV 62° |
| Iris Type | Fixed |
| Lens Mount | M12 |
| DORI | |
| DORI | 2.8 mm: D: 60.0 m, O: 23.8 m, R: 12.0 m, I: 6.0 m 4 mm: D: 80.0 m, O: 31.7 m, R: 16.0 m, I: 8.0 m 6 mm: D: 120.0 m, O: 47.6 m, R: 24.0 m, I: 12.0 m |
| Illuminator | |
| Supplement Light Type | IR |
| Supplement Light Range | Up to 30 m |
| Smart Supplement Light | Yes |
| IR Wavelength | 850 nm |
| Video | |
| Main Stream | 50 Hz: 25 fps (2688 × 1520, 1920 × 1080, 1280 × 720) 60 Hz: 30 fps (2688 × 1520, 1920 × 1080, 1280 × 720) |
| Sub-Stream | 50 Hz: 25 fps (1280 × 720, 640 × 480, 640 × 360) 60 Hz: 30 fps (1280 × 720, 640 × 480, 640 × 360) |
| Third Stream | 50 Hz: 10 fps (1920 × 1080, 1280 × 720, 640 × 480, 640 × 360) 60 Hz: 10 fps (1920 × 1080, 1280 × 720, 640 × 480, 640 × 360) *Third stream is supported under certain settings. |
| Video Compression | Main stream: H.265/H.264/H.265+/H.264+ Sub-stream: H.265/H.264/MJPEG Third stream: H.265/H.264 *Third stream is supported under certain settings. |
| Video Bit Rate | 32 Kbps to 8 Mbps |
| H.264 Type | Baseline Profile/Main Profile/High Profile |
| H.265 Type | Main Profile |
| Bit Rate Control | CBR/VBR |
| Scalable Video Coding (SVC) | H.264 and H.265 encoding |
| Region of Interest (ROI) | 1 fixed region for main stream and sub-stream |
| Audio | |
| Audio Compression | -S: G.711ulaw/G.711alaw/G.722.1/G.726/MP2L2/PCM/MP3/AAC-LC |

| | |
|-----------------------------|--|
| Audio Bit Rate | -S: 64 Kbps (G.711ulaw/G.711alaw)/16 Kbps (G.722.1)/16 Kbps (G.726)/32 to 192 Kbps (MP2L2)/8 to 320 Kbps (MP3)/16 to 64 Kbps (AAC-LC) |
| Audio Sampling Rate | -S: 8 kHz/16 kHz/32 kHz/44.1 kHz/48 kHz |
| Environment Noise Filtering | -S: Yes |
| Network | |
| Protocols | TCP/IP, ICMP, HTTP, HTTPS, FTP, DHCP, DNS, DDNS, RTP, RTSP, NTP, UPnP, SMTP, IGMP, 802.1X, QoS, IPv4, IPv6, UDP, Bonjour, SSL/TLS, PPPoE, SNMP, ARP, WebSocket, WebSockets |
| Simultaneous Live View | Up to 6 channels |
| API | Open Network Video Interface (PROFILE S, PROFILE G, PROFILE T), ISAPI, SDK |
| User/Host | Up to 32 users. 3 user levels: administrator, operator and user |
| Security | Password protection, complicated password, HTTPS encryption, IP address filter, Security Audit Log, basic and digest authentication for HTTP/HTTPS, TLS 1.1/1.2, WSSE and digest authentication for Open Network Video Interface |
| Network Storage | NAS (NFS, SMB/CIFS), auto network replenishment (ANR) Together with high-end Hikvision memory card, memory card encryption and health detection are supported. |
| Client | iVMS-4200, Hik-Connect, Hik-Central |
| Web Browser | Plug-in required live view: IE 10, IE 11 Plug-in free live view: Chrome 57.0+, Firefox 52.0+, Edge 89+ Local service: Chrome 57.0+, Firefox 52.0+, Edge 89+ |
| Image | |
| Image Parameters Switch | Yes |
| Image Settings | Rotate mode, saturation, brightness, contrast, sharpness, gain, white balance adjustable by client software or web browser |
| Day/Night Switch | Day, Night, Auto, Schedule |
| Wide Dynamic Range (WDR) | 120 dB |
| SNR | ≥ 52 dB |
| Image Enhancement | BLC, HLC, 3D DNR |
| Interface | |
| Ethernet Interface | 1 RJ45 10 M/100 M self-adaptive Ethernet port |
| On-Board Storage | Built-in memory card slot, support microSD/SDHC/SDXC card, up to 512 GB |
| Built-in Microphone | -U: Yes |
| Audio | -S: 1 input (line in), two-core terminal block, max. input amplitude: 3.3 Vpp, input impedance: 4.7 KΩ, interface type: non-equilibrium; 1 output (line out), two-core terminal block, max. output amplitude: 3.3 Vpp, output impedance: 100 Ω, interface type: non-equilibrium |
| Alarm | -S: 1 input, 1 output (max. 12 VDC, 30 mA) |
| Reset Key | Yes |
| Event | |
| Basic Event | Motion detection (human and vehicle targets classification), video tampering alarm, exception |
| Smart Event | Line crossing detection, intrusion detection, region entrance detection, region exiting detection (support alarm triggering by specified target types (human and vehicle)) Scene change detection |

| | |
|----------------------------------|---|
| Linkage | Upload to NAS/memory card/FTP, notify surveillance center, trigger recording, trigger capture, send email, audible warning |
| Deep Learning Function | |
| Face Capture | Yes |
| General | |
| Power | 12 VDC \pm 25%, 0.4 A, max. 5 W, \varnothing 5.5 mm coaxial power plug, reverse polarity protection PoE: 802.3af, Class 3, 36 V to 57 V, 0.20 A to 0.15 A, max. 6.5 W |
| Dimension | \varnothing 121.4 mm \times 92.2 mm (\varnothing 4.8" \times 3.6") |
| Package Dimension | 150 mm \times 150 mm \times 141 mm (5.9" \times 5.9" \times 5.6") |
| Weight | Approx. 580 g (1.3 lb.) |
| With Package Weight | Approx. 820 g (1.8 lb.) |
| Storage Conditions | -30 °C to 60 °C (-22 °F to 140 °F). Humidity 95% or less (non-condensing) |
| Startup and Operating Conditions | -30 °C to 60 °C (-22 °F to 140 °F). Humidity 95% or less (non-condensing) |
| Language | 33 languages English, Russian, Estonian, Bulgarian, Hungarian, Greek, German, Italian, Czech, Slovak, French, Polish, Dutch, Portuguese, Spanish, Romanian, Danish, Swedish, Norwegian, Finnish, Croatian, Slovenian, Serbian, Turkish, Korean, Traditional Chinese, Thai, Vietnamese, Japanese, Latvian, Lithuanian, Portuguese (Brazil), Ukrainian |
| General Function | Anti-flicker, heartbeat, mirror, privacy mask, flash log, password reset via email, pixel counter |
| Approval | |
| EMC | FCC (47 CFR Part 15, Subpart B); CE-EMC (EN 55032: 2015, EN 61000-3-2: 2014, EN 61000-3-3: 2013, EN 50130-4: 2011 +A1: 2014); RCM (AS/NZS CISPR 32: 2015); KC (KN 32: 2015, KN 35: 2015) |
| Safety | UL (UL 60950-1); CB (IEC 60950-1:2005 + Am 1:2009 + Am 2:2013); CE-LVD (EN 60950-1:2005 + Am 1:2009 + Am 2:2013); LOA (IEC/EN 60950-1) |
| Environment | CE-RoHS (2011/65/EU); WEEE (2012/19/EU); Reach (Regulation (EC) No 1907/2006) |
| Protection | IP67 (IEC 60529-2013), IK10 (IEC 62262:2002) |

▪ Available Model

DS-2CD2146G2-I(4mm)(NED PG)Black
DS-2CD2146G2-I(2.8mm)(NED PG)Black
DS-2CD2146G2-ISU(2.8mm)
DS-2CD2146G2-ISU(6mm)
DS-2CD2146G2-ISU(4mm)
DS-2CD2146G2-ISU(2.8mm)(LTU BK)
DS-2CD2146G2-ISU(4mm)(BK HIK)
DS-2CD2146G2-ISU(4mm)(BK BLACK)
DS-2CD2146G2-IS(2.8mm)(C)
DS-2CD2146G2-IS(4mm)(C)
DS-2CD2146G2-IS(6mm)(C)
DS-2CD2146G2-ISU(2.8mm)(C)(BLACK)

- DS-2CD2146G2-IS(2.8mm)
- DS-2CD2146G2-IS(6mm)
- DS-2CD2146G2-IS(4mm)
- DS-2CD2146G2-I(4mm)
- DS-2CD2146G2-I(2.8mm)
- DS-2CD2146G2-I(6mm)
- DS-2CD2146G2-I(4mm)(C)
- DS-2CD2146G2-I(2.8mm)(C)
- DS-2CD2146G2-I(6mm)(C)
- DS-2CD2146G2-ISU(4mm)(C)
- DS-2CD2146G2-ISU(2.8mm)(C)
- DS-2CD2146G2-ISU(6mm)(C)

▪ **Dimension**

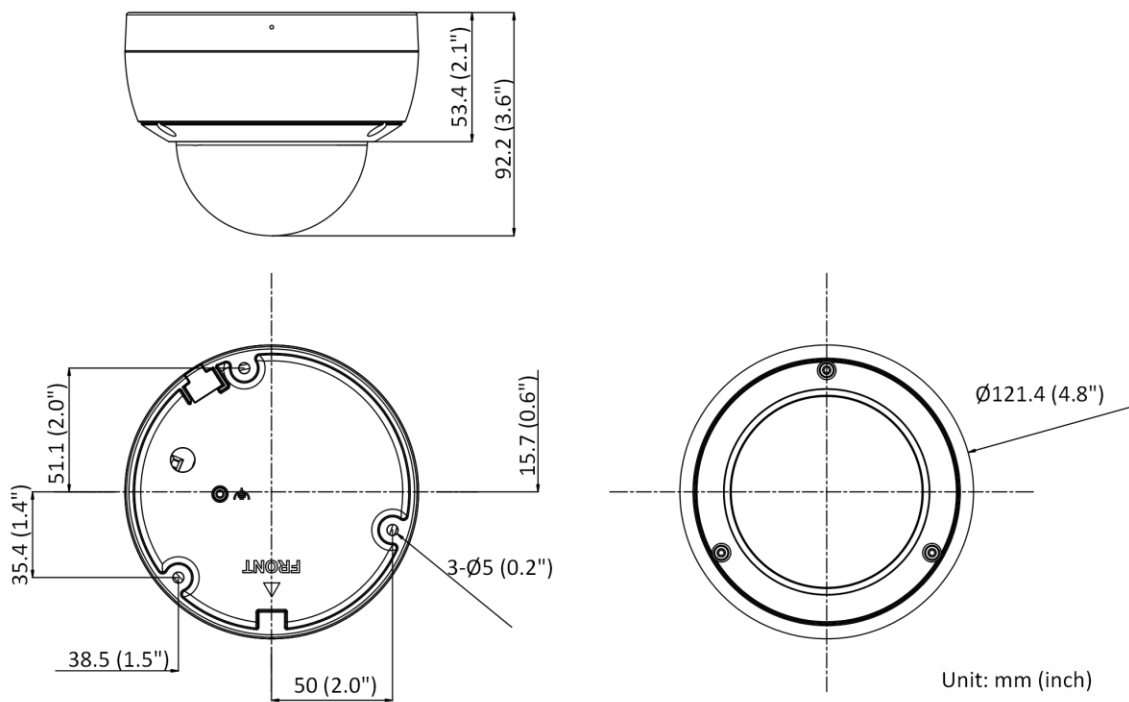



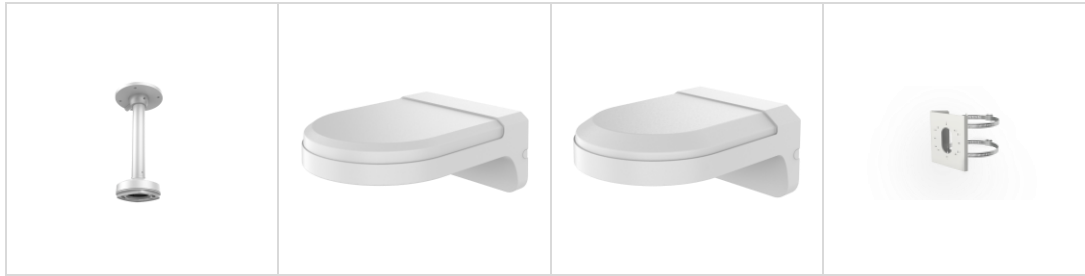

▪ **Accessory**

▪ **Optional**

| DS-1272ZJ-120 | DS-1280ZJ-DM46 | DS-1276ZJ-SUS | DS-1275ZJ-SUS | DS-1272ZJ-120B |
|---------------|------------------|------------------|-----------------|----------------|
| | | | | |
| DS-1271ZJ-120 | DS-220AZJ-130-WA | DS-220AZJ-145-WA | DS-1275ZJ-S-SUS | |

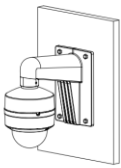
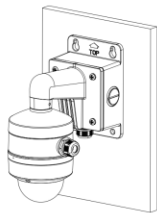
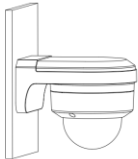
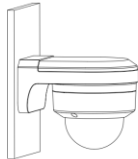
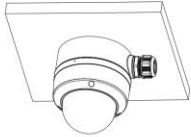

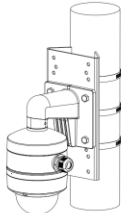
▪ **Installation Methods**

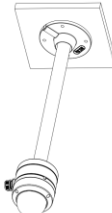
| | | | | |
|---|---|---|---|---|
| <p>Wall Mounting DS-1272ZJ-120</p> | <p>Wall Mounting DS-1272ZJ-120B+DS-1280ZJ-DM46</p> | <p>Wall Mounting DS-220AZJ-130-WA</p> | <p>Wall Mounting DS-220AZJ-145-WA</p> | <p>Junction Box DS-1280ZJ-DM46</p> |
|  |  |  |  |  |
| <p>Corner Mounting DS-1276ZJ-SUS+DS-1272ZJ-120+DS-1280ZJ-DM46</p> | <p>Vertical Pole Mounting DS-1275ZJ-SUS+DS-1272ZJ-120+DS-1280ZJ-DM46</p> | <p>Vertical Pole Mounting DS-1275ZJ-S-SUS+DS-220AZJ-130-WA</p> | <p>Pendant Mounting DS-1271ZJ-120+DS-1280ZJ-DM46</p> | |
|  |  |  |  | |

See Far, Go Further



www.hikvision.com
support@hikvision.com

