

**DS-2CD1127G2-LUF  
2 MP ColorVu MD 2.0 Fixed Dome Network Camera**

Hikvision ColorVu technology provides 24/7 vivid colorful images with F1.0 advanced lenses and high performance sensors. F1.0 super-aperture collects more light to produce brighter images. Advanced sensor technology can vastly improve the utilization of available light.

- High quality imaging with 2 MP resolution
- 24/7 colorful imaging
- Support Human and Vehicle Detection
- Water and dust resistant (IP67) and vandal resistant (IK08)
- Efficient H.265+ compression technology
- Support on-board storage up to 256GB (SD card slot)(Optional)
- Built-in microphone for real-time audio security(Optional)

## ▪ Specification

| Camera                      |  |
|-----------------------------|--|
| Image Sensor                | 1/2.8" Progressive Scan CMOS   |
| Max. Resolution             | 1920 × 1080  |
| Min. Illumination           | Color: 0.001 Lux @ (F1.0, AGC ON), 0 Lux with light  |
| Shutter Time                | 1/3 s to 1/100,000 s   |
| Day & Night                 | 24/7 color imaging   |
| Angle Adjustment            | Pan: 0° to 355°, tilt: 0° to 75°, rotate: 0° to 355°   |
| Lens                        |  |
| Lens Type                   | Fixed focal lens, 2.8 and 4 mm optional  |
| Focal Length & FOV          | 2.8 mm, horizontal FOV: 106°, vertical FOV: 57°, diagonal FOV: 126°<br>4 mm, horizontal FOV: 83°, vertical FOV: 44°, diagonal FOV: 99° |
| Lens Mount                  | M12  |
| Iris Type                   | Fixed  |
| Aperture                    | F1.0   |
| Depth of Field              | 2.8 mm: 1.5 m to ∞<br>4 mm: 2.1 m to ∞   |
| DORI                        |  |
| DORI                        | 2.8 mm, D: 44 m, O: 17 m, R: 8 m, I: 4 m<br>4 mm, D: 56 m, O: 22 m, R: 11 m, I: 5 m  |
| Illuminator                 |  |
| Supplement Light Type       | White Light  |
| Supplement Light Range      | Up to 30 m   |
| Smart Supplement Light      | Yes  |
| Video                       |  |
| Main Stream                 | 50 Hz: 25 fps (1920 × 1080, 1280 × 720)<br>60 Hz: 30 fps (1920 × 1080, 1280 × 720)   |
| Sub-Stream                  | 50 Hz: 25 fps (640 × 480, 640 × 360)<br>60 Hz: 30 fps (640 × 480, 640 × 360)   |
| Video Compression           | Main stream: H.265+/H.265/H.264+/H.264,<br>Sub-stream: H.265/H.264/MJPEG   |
| Video Bit Rate              | 32 Kbps to 8 Mbps  |
| H.264 Type                  | Baseline Profile, Main Profile, High Profile   |
| H.265 Type                  | Main Profile   |
| Bit Rate Control            | CBR, VBR   |
| Region of Interest (ROI)    | 1 fixed region(s) for main stream  |
| Audio                       |  |
| Audio Type                  | -U: Mono sound   |
| Audio Compression           | -U: G.711ulaw/G.711alaw/G.722.1/G.726/MP2L2/PCM/AAC-LC   |
| Audio Bit Rate              | -U: 64 Kbps (G.711 ulaw)/64 Kbps (G.711 alaw)/16 Kbps (G.722.1)/16 Kbps (G.726)/32 to 160 Kbps (MP2L2)/16 to 64 Kbps (AAC-LC)          |
| Audio Sampling Rate         | -U: 8 kHz/16 kHz   |
| Environment Noise Filtering | -U: Yes  |

| Network                          |  |
|----------------------------------|--|
| Security                         | Password protection, complicated password, watermark, basic and digest authentication for HTTP, WSSE and digest authentication for Open Network Video Interface, security audit log, host authentication (MAC address) |
| Simultaneous Live View           | Up to 6 channels   |
| API                              | Open Network Video Interface (Profile S, Profile T, Profile G (only -U model supports)), ISAPI, SDK  |
| Protocols                        | TCP/IP, ICMP, DHCP, DNS, HTTP, RTP, RTSP, NTP, IGMP, IPv6, UDP, QoS, FTP, SMTP   |
| User/Host                        | Up to 32 users<br>3 user levels: administrator, operator, and user   |
| Client                           | iVMS-4200, Hik-Connect   |
| Web Browser                      | Plug-in required live view: IE 10, IE 11,<br>Local service: Chrome 57.0+, Firefox 52.0+  |
| Image                            |  |
| Wide Dynamic Range (WDR)         | Digital WDR  |
| SNR                              | ≥ 52 dB  |
| Day/Night Switch                 | Day, Night, Auto, Schedule   |
| Image Enhancement                | BLC, HLC, 3D DNR   |
| Image Settings                   | Rotate mode, saturation, brightness, contrast, sharpness, gain, white balance, adjustable by client software or web browser  |
| Privacy Mask                     | 4 programmable polygon privacy masks   |
| Interface                        |  |
| Ethernet Interface               | 1 RJ45 10 M/100 M self-adaptive Ethernet port  |
| On-Board Storage                 | Built-in memory card slot, support microSD/microSDHC/microSDXC card, up to 256 GB  |
| Built-in Microphone              | -U: Yes  |
| Reset Key                        | -F: Yes  |
| Event                            |  |
| Basic Event                      | Motion detection (support alarm triggering by specified target types (human and vehicle)), video tampering alarm, exception  |
| Linkage                          | Upload to FTP/memory card (-F), notify surveillance center, send email, trigger recording (-F), trigger capture  |
| General                          |  |
| Power                            | 12 VDC ± 25%, 0.4 A, max. 5 W, Ø5.5 mm coaxial power plug,<br>PoE: 802.3af, Class 3, 36 V to 57 V, 0.2 A to 0.15 A, max. 6.5 W   |
| Material                         | Base: aluminum alloy, cover: plastic   |
| Dimension                        | Ø121.5 mm × 97.6 mm (Ø4.8" × 3.8")   |
| Package Dimension                | 150 mm × 150 mm × 141 mm (5.9" × 5.9" × 5.6")  |
| Weight                           | Approx. 500 g (1.1 lb.)  |
| With Package Weight              | Approx. 700 g (1.5 lb.)  |
| Storage Conditions               | -30 °C to 60 °C (-22 °F to 140 °F). Humidity 95% or less (non-condensing)  |
| Startup and Operating Conditions | -30 °C to 60 °C (-22 °F to 140 °F). Humidity 95% or less (non-condensing)  |
| Language                         | English, Ukrainian   |
| General Function                 | Heartbeat, anti-banding, mirror, password protection, password reset via email   |

| Approval    |   |
|-------------|---|
| EMC         | FCC: 47 CFR Part 15, Subpart B,<br>CE-EMC: EN 55032: 2015, EN 61000-3-2:2019, EN 61000-3-3: 2013+A1:2019, EN 50130-4:2011 +A1: 2014,<br>RCM: AS/NZS CISPR 32: 2015,<br>KC: KN32: 2015, KN35: 2015 |
| Safety      | UL: UL 62368-1,<br>CB: IEC 62368-1:2014+A11,<br>CE-LVD: EN 62368-1:2014/A11: 2017,<br>BIS: IS 13252 (Part 1): 2010/IEC 60950-1: 2005  |
| Environment | CE-RoHS: 2011/65/EU,<br>WEEE: 2012/19/EU,<br>Reach: Regulation (EC) No 1907/2006  |
| Protection  | IP67: IEC 60529-2013, IK08: IEC 62262:2002  |

## ▪ Typical Application

Hikvision products are classified into three levels according to their anti-corrosion performance. Refer to the following description to choose for your using environment.

This model has NO SPECIFIC PROTECTION.

| Level                  | Description  |
|------------------------|--|
| Top-level protection   | Hikvision products at this level are equipped for use in areas where professional anti-corrosion protection is a must. Typical application scenarios include coastlines, docks, chemical plants, and more.   |
| Moderate protection    | Hikvision products at this level are equipped for use in areas with moderate anti-corrosion demands. Typical application scenarios include coastal areas about 2 kilometers (1.24 miles) away from coastlines, as well as areas affected by acid rain. |
| No specific protection | Hikvision products at this level are equipped for use in areas where no specific anti-corrosion protection is needed.  |

## ▪ Dimension

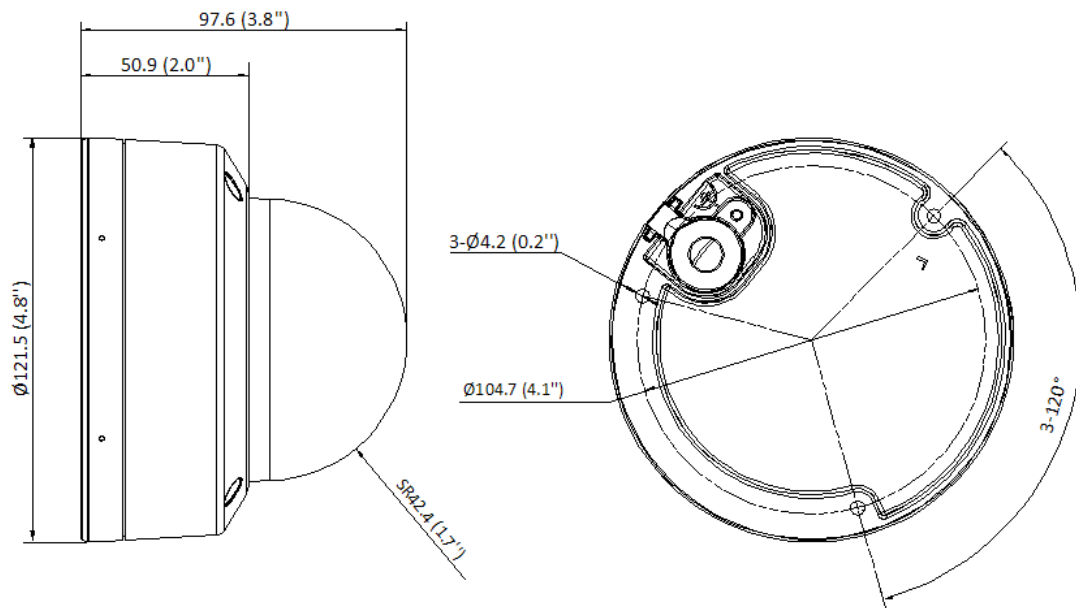

Unit: mm (inch)





▪ **Accessory**

▪ **Optional**

| DS-1275ZJ-S-SUS | DS-1275ZJ-SUS    | DS-1271ZJ-120 | DS-1280ZJ-DM46 | DS-1272ZJ-120    |
|-----------------|------------------|---------------|----------------|------------------|
|                 |                  |               |                |                  |
| DS-1276ZJ-SUS   | DS-1475ZJ-SUS    | DS-1476ZJ-SUS | DS-1272ZJ-120B | DS-220AZJ-130-WA |
|                 |                  |               |                |                  |
| DS-4221ZJ-WC    | DS-220AZJ-145-WA |               |                |                  |

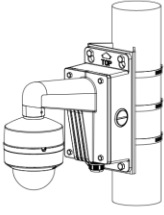

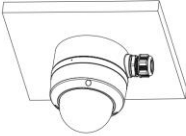
▪ **Installation Methods**

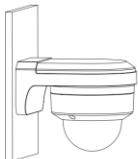
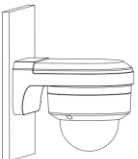
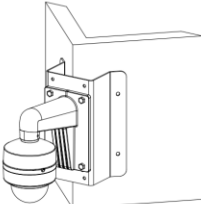
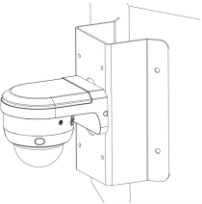
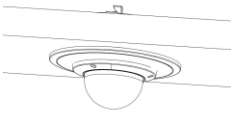
|   |   |   |   |   |
|---|---|---|---|---|
| <p><b>Vertical Pole Mounting</b><br/>DS-1275ZJ-S-SUS+DS-220AZJ-145-WA</p>           | <p><b>Vertical Pole Mounting</b><br/>DS-1275ZJ-SUS+DS-1272ZJ-120B</p>               | <p><b>Vertical Pole Mounting</b><br/>DS-1475ZJ-SUS+DS-220AZJ-130-WA</p>             | <p><b>Pendant Mounting</b><br/>DS-1271ZJ-120+DS-1280ZJ-DM46</p>                       | <p><b>Junction Box</b><br/>DS-1280ZJ-DM46</p>   |
|    |    |    |    |    |
| <p><b>Wall Mounting</b><br/>DS-1272ZJ-120+DS-1280ZJ-DM46</p>                        | <p><b>Wall Mounting</b><br/>DS-1272ZJ-120B</p>                                      | <p><b>Wall Mounting</b><br/>DS-220AZJ-130-WA</p>                                    | <p><b>Wall Mounting</b><br/>DS-220AZJ-145-WA</p>                                      | <p><b>Corner Mounting</b><br/>DS-1276ZJ-SUS+DS-1272ZJ-120</p>                         |
|  |  |  |  |  |
| <p><b>Corner Mounting</b><br/>DS-1476ZJ-SUS+DS-220AZJ-130-WA</p>                    | <p><b>In-Ceiling Mounting</b><br/>DS-4221ZJ-WC</p>                                  |   |   |   |
|  |  |   |   |   |

# See Far, Go Further



[www.hikvision.com](http://www.hikvision.com)  
[support@hikvision.com](mailto:support@hikvision.com)

