

IDS-2CD71166G2-IZHSY**16MP DeepinView Moto Varifocal Dome Camera****DeepinView^{series}****DarkFighter^{2.0}**

Hikvision has been dedicated to develop products with security since established.

Hikvision always follows security by design principle and has adopted many methods of security technologies into our product development lifecycle, including terminal security, data security, application security, network security, and privacy protection.

In the meantime, the security technologies used by Hikvision are all in compliance with local applicable laws and safety regulations. These security measures could enhance product's cyber security protection capability and protect your devices as well as your data from malicious cyber attacks.

- High quality imaging with 16 MP resolution
- Excellent low-light performance via DarkFighter 2.0 technology
- Clear imaging against strong back light due to 120 dB AWDR technology
- Efficient H.265+ compression technology to save bandwidth and storage
- 5 streams to meet a wide variety of applications
- Water and dust resistant (IP67), vandal proof (IK10) and corrosion resistant (NEMA 4X, optional)
- Built-in dual-mic and speaker for real-time audio security
- Built-in G-sensor for vibration detection
- Built-in power meter for historical power statistics

▪ Function

Face Capture

With embedded deep learning based algorithms, the camera is able to give the best shot of a target face through detecting, capturing, grading and selecting. The camera uses face exposure function to dynamically adjust face area exposure of captures and ensures high face picture quality.

Perimeter Protection

With embedded deep learning based target detection and classification algorithms, the camera carries out the duty of perimeter protection, monitoring the actions of line crossing, intrusion, region entrance, and region exiting. The algorithms greatly filter out the mistaken alarm caused by the interference of leaves, lights, animal, flag, etc.

Multi-Target-Type Detection

With the embedded deep learning algorithms, the camera detects and captures the face, human body, vehicle in the specified region.

Queue Management

With embedded deep learning based algorithms, the camera detects queuing-up people number and waiting time of each person. It can generate reports to compare the efficiency of different queuing-ups and display the changing status of one queue, and supports raw data export for further analysis.

Regional People Counting

With the embedded deep learning algorithms, the camera supports people density detection and will upload detection data through scheduled uploading, number of people change uploading and congestion level uploading. It also supports number of people exception detection and waiting time exception detection.

On/Off Duty Detection

With the embedded deep learning algorithms, the camera supports absence detection and on/off duty detection. It can detect the on/off duty status and people number changes in a predefined area.

Heat Map

The camera can generate a graphic description of visits (by calculating amount of people or amount of dwell time) in a configured area.

Multi-Dimension People Counting

With the embedded deep learning algorithms, the camera integrates multiple intelligences. It counts persons and compares them with the built-in face picture library to remove duplicates. It counts persons and reports an alarm simultaneously to achieve both the entrance control and people counting.

PPE Detection

With the embedded deep learning algorithms, the camera detects the persons in the specified region. It detects whether the person is wearing a hard hat and reflective clothing, and reports an alarm if not.

▪ Specification

| Camera | |
|------------------------|---|
| Image Sensor | 1/1.8" Progressive Scan CMOS |
| Max. Resolution | 4608 × 3456 |
| Min. Illumination | Color: 0.005 Lux @ (F1.2, AGC ON), B/W: 0.002 Lux @ (F1.2, AGC ON), B/W: 0 Lux with IR |
| Shutter Time | 1 s to 1/100,000 s |
| Day & Night | IR cut filter, Blue glass module (less ghost phenomenon) |
| Angle Adjustment | Pan: 0° to 355°, tilt: 0° to 75°, rotate: 0° to 355° |
| Lens | |
| Lens Type | Varifocal lens, motorized lens, 2.8 to 12 mm and 8 to 32 mm optional |
| Focal Length & FOV | 2.8 to 12 mm, horizontal FOV 101.2°~43.8°, vertical FOV 72.6°~32.8°, diagonal FOV 139°~54.9° 8 to 32 mm, horizontal FOV 38.4°~13.8°, vertical FOV 28.4°~10.4°, diagonal FOV 49.1°~17.2° |
| Lens Mount | CS mount |
| Focus | Auto, Semi-auto, Manual |
| Iris Type | P-iris |
| Aperture | 2.8 to 12 mm: F1.38 to F2.1, 8 to 32 mm: F1.7 to F1.73 |
| DORI | |
| OODPCVS | <p>Wide:</p> <p>2.8 to 12 mm: Overview: 141.9 m, Outline: 71.0 m, Discern: 35.5 m, Perceive: 22.7 m, Characterize: 11.4 m, Validate: 5.7 m, Scrutinize: 1.9 m 8 to 32 mm: Overview: 351.6 m, Outline: 175.8 m, Discern: 87.9 m, Perceive: 56.3 m, Characterize: 28.1 m, Validate: 14.1 m, Scrutinize: 4.7 m</p> <p>Tele:</p> <p>2.8 to 12 mm: Overview: 300.0 m, Outline: 150.0 m, Discern: 75.0 m, Perceive: 48.0 m, Characterize: 24.0 m, Validate: 12.0 m, Scrutinize: 4.0 m 8 to 32 mm: Overview: 935.5 m, Outline: 467.7 m, Discern: 233.9 m, Perceive: 149.7 m, Characterize: 74.8 m, Validate: 37.4 m, Scrutinize: 12.5 m</p> <p>The OODPCVS values are calculated using pixel densities for different use cases as recommended by the IEC/EN 62676-4:2025 standard. IEC 62676-4:2025 describes the planning, design, installation, testing, commissioning, and maintaining of video surveillance systems (VSS) comprising image capture device(s), interconnection(s) and image handling device(s), for use in security applications within private or public spaces.</p> |
| Illuminator | |
| Supplement Light Type | IR |
| Supplement Light Range | 2.8 to 12 mm: Monitoring: 40 m; 8 to 32 mm: Monitoring: 60 m |
| Smart Supplement Light | Yes |
| IR Wavelength | 850 nm |

| HEOP | |
|-----------------------------|--|
| Open Resources | Memory: 150 MB, Smart RAM: 2200 MB, eMMC: 1288 MB |
| Computing Power | 5 TOPS |
| Open Capability | HEOP 2.0 OpenevSDK |
| Deep Learning Structure | Caffe,PyTorch,TensorFlow |
| Programming Language | C,C++ |
| AI Open Platform | |
| Model Specification | Up to 4 models, Model type: detection model, classification model, mixed model (detection model and classification model) |
| Video | |
| Main Stream | Monitoring mode: 50 Hz: up to 50 fps (3840 × 2160, 3072 × 1728, 2560 × 1440, 1280 × 720), up to 100 fps (1920 × 1080) 60 Hz: up to 60 fps (3840 × 2160, 3072 × 1728, 2560 × 1440, 1280 × 720), up to 120 fps (1920 × 1080) 50 Hz: 25 fps (4608 × 3456, 4000 × 3000, 4608 × 2592) 60 Hz: 30 fps (4608 × 3456, 4000 × 3000, 4608 × 2592) *High frame rate is supported under monitoring mode only. smart mode: 50 Hz: 25 fps (4608 × 3456, 4000 × 3000, 3840 × 2160, 3072 × 1728, 2560 × 1440, 1920 × 1080, 1280 × 720) 60 Hz: 30 fps (4608 × 3456, 4000 × 3000, 3840 × 2160, 3072 × 1728, 2560 × 1440, 1920 × 1080, 1280 × 720) |
| Sub-Stream | 50 Hz: 25 fps (1280 × 720, 704 × 576, 640 × 480) 60 Hz: 24 fps (1280 × 720, 704 × 480, 640 × 480) |
| Third Stream | 50 Hz: 25 fps (1920 × 1080 , 1280 × 720, 704 × 576, 640 × 480) 60 Hz: 30fps (1920 × 1080 , 1280 × 720, 704 × 480, 640 × 480) |
| Fourth Stream | 50 Hz: 25 fps (1280 × 720, 704 × 576, 640 × 480) 60 Hz: 24 fps (1280 × 720, 704 × 480, 640 × 480) |
| Fifth Stream | 50 Hz: 25 fps (1280 × 720, 704 × 576, 640 × 480) 60 Hz: 24 fps (1280 × 720, 704 × 480, 640 × 480) |
| Video Compression | Main stream: H.265+/H.265/H.264+/H.264, Sub-stream: H.265/H.264/MJPEG, Third stream: H.265/H.264, Fourth stream: H.265/H.264/MJPEG, Fifth stream: H.265/H.264/MJPEG |
| Video Bit Rate | 32 Kbps to 32 Mbps |
| H.264 Type | Baseline Profile,Main Profile,High Profile |
| H.265 Type | Main Profile |
| Bit Rate Control | CBR,VBR |
| Scalable Video Coding (SVC) | H.264 and H.265 encoding |
| Region of Interest (ROI) | 4 fixed regions for each stream |

| | |
|-----------------------------|---|
| Target Cropping | Yes |
| e-PTZ | Support Patrol and Auto Tracking settings |
| Audio | |
| Audio Type | Mono sound |
| Audio Compression | G.711/G.722.1/G.726/MP2L2/PCM/MP3/AAC-LC |
| Audio Bit Rate | 64 Kbps (G.711ulaw/G.711alaw)/16 Kbps (G.722.1)/16 Kbps (G.726)/32 to 192 Kbps (MP2L2)/8 to 320 Kbps (MP3)/16 to 64 Kbps (AAC-LC) |
| Audio Sampling Rate | 8 kHz/16 kHz/32 kHz/48 kHz |
| Environment Noise Filtering | Yes |
| Network | |
| Protocols | TCP/IP, ICMP, HTTP, HTTPS, FTP, DHCP, DNS, DDNS, RTP, SRTP, RTSP, RTCP, PPPoE, NTP, UPnP, SMTP, SNMP, IGMP, 802.1X, QoS, IPv4, IPv6, UDP, Bonjour, WebSocket, WebSockets, MQTT/MQTTS, RTMP, Support X.509 authentication |
| Simultaneous Live View | Up to 20 channels |
| API | ISAPI,SDK,ISUP,OTAP,ONVIF (ProfileS, ProfileG, ProfileT, ProfileM) |
| User/Host | Up to 32 users 3 user levels: administrator, operator, and user |
| Smooth Streaming | Yes |
| Security | Password protection, complicated password, HTTPS encryption, 802.1X authentication (EAP-TLS, EAP-LEAP, EAP-MD5), watermark, IP address filter, basic and digest authentication for HTTP/HTTPS, WSSE and digest authentication for Open Network Video Interface, RTP/RTSP OVER HTTPS, Control Timeout Settings, Security Audit Log, TLS 1.2, TLS 1.3, TPM 2.0 (FIPS 140-2 level 2), AES128/256 |
| Client | iVMS-4200,Hik-Connect,Hik-Central |
| Network Storage | NAS (NFS, SMB/CIFS),Auto Network Replenishment (ANR), Cloud Storage, Together with high-end Hikvision memory card, memory card encryption and health detection are supported. |
| Web Browser | Plug-in required live view: IE 10, IE 11, Plug-in free live view: Chrome 57.0+, Firefox 52.0+, Edge 89+, Safari 11+, Local service: Chrome 57.0+, Firefox 52.0+, Edge 89+ |
| Image | |
| Image Parameters Switch | Yes |
| Image Settings | Rotate mode,saturation,brightness,contrast,sharpness,white balance,AGC,adjustable by client software or web browser |
| Day/Night Switch | Day,Night,Auto,Schedule,Alarm Trigger |
| Wide Dynamic Range (WDR) | 120 dB |
| Image Enhancement | BLC,HLC,3D DNR,Distortion Correction,Defog |
| Privacy Mask | 8 programmable polygon privacy masks |
| SNR | ≥ 52 dB |
| Picture Overlay | LOGO picture can be overlaid on video with 128 × 128 24 bit bmp format. |
| Image Stabilization | EIS |
| Interface | |
| Video Output | 1 Vp-p Composite Output (75 Ω/CVBS) (Only for debugging) |
| Ethernet Interface | 1 RJ45 10 M/100 M/1000 M self-adaptive Ethernet port |
| On-Board Storage | Built-in memory card slot, support microSD/microSDHC/microSDXC card, up to 1 TB |

| | |
|-------------------------------|--|
| Built-in Microphone | Yes,1 built-in microphone |
| Built-in Speaker | Max. power consumption: 1.5 W, max. sound pressure level: 98 dB, speaker range: 10 m |
| Audio | 1 input (line in), 3.5 mm connector, three-contact, max. input amplitude: 3.3 Vpp, input impedance: 4.7 K Ω , interface type: non-equilibrium, 1 output (line out), 3.5 mm connector, three-contact, max. output amplitude: 3.3 Vpp, output impedance: 100 Ω , interface type: non-equilibrium, mono sound |
| Alarm | 2 inputs, 2 outputs (max. 24 VDC/24 VAC, 1 A) |
| RS-485 | 1 RS-485 (Half duplex, HIKVISION, Pelco-P, Pelco-D, self-adaptive) |
| Reset Key | Yes |
| Power Output | 12 VDC, max. 100 mA |
| Event | |
| Basic Event | glass break detection,scream detection,gunshot and explosion sound detection,crying sound detection,video tampering alarm,alarm input and output,video quality diagnosis,Motion detection (support alarm triggering by specified target types (human and vehicle)),exception (network disconnected, IP address conflict, illegal login, HDD full, HDD error, abnormal restart) |
| Smart Event | Line crossing detection, intrusion detection, region entrance detection, region exiting detection,loitering detection,people gathering detection,fast moving detection,parking detection, unattended baggage detection, object removal detection |
| Linkage | Upload to FTP/NAS/memory card,notify surveillance center,send email,trigger alarm output,trigger recording,trigger capture,audible warning,HTTP custom alarm |
| Deep Learning Function | |
| Multi-target-type Detection | Supports dynamic mosaic mask, Supports ShotN technology, Supports simultaneous detection and capture of human body, face, and vehicle, Gets 7 face features, Gets 13 human body features, Gets 2 vehicle features, Supports counting the number of line crossing targets by type, including human body, non-motor vehicle, motor vehicle, Supports license plate recognition |
| Face Capture | Detects up to 120 faces simultaneously, captures up to 40 face pictures per frame simultaneously and uploads up to 10 face pictures per second, Supports swing left and right from -70° to 70°, tilt up and down from -50° to 50°, Uploads face with background and closed-up face pictures, Supports best shot and quick shot for capture mode, Supports dynamic mosaic mask, Gets 7 face features |
| Face Comparison | Up to 10 face libraries. 30,000 faces for each library. 150,000 faces in total, Supports face library encryption |
| Perimeter Protection | Line crossing, intrusion, region entrance, region exiting Support alarm triggering by specified target types (human and vehicle) Support combined event alarm triggering |

| | |
|-------------------|---|
| Activity Analysis | Support the detection of person smoking or making phone calls and trigger alarm. The detection attributes include head and shoulders, hands, faces, making phone calls, and smoking. |
| People Counting | <p>Supports Multi-Dimension People Counting,</p> <p>Supports counting, displaying and exporting the people flow data of entering, exiting and passing by (The data is stored in the flash.),</p> <p>Supports real-time uploading and uploading by statistic cycle,</p> <p>Supports generating daily, weekly, monthly or annually reports,</p> <p>Supports dynamic deduplication based on face picture comparison, and can filter out the target with the same custom face pictures, same attributes, or filter out repeated invalid targets within the set time interval,</p> <p>Supports face feature deduplication,</p> <p>Supports people flow data replenishment,</p> <p>Reverse counting alarm will be triggered when the target leaves the detection area in the direction opposite to the set direction</p> |
| Queue Management | <p>Supports up to 8 detection regions, and independent arming schedule and linkage method</p> <p>Supports 2 detection modes: regional people queuing-up, waiting time detection</p> <p>Generates reports to compare the efficiency of different queuing-ups and display the changing status of one queue</p> <p>Supports raw data export for further analysis</p> <p>Supports real-time data uploading and scheduled data uploading</p> <p>Regional people queuing-up: supports 4 alarm trigger conditions, including greater than threshold, less than threshold, equal to threshold, not equal to threshold</p> <p>Waiting time detection: supports 1 alarm trigger condition, including greater than threshold</p> <p>Supports combined rule settings for Regional People Counting and Waiting Time Detection.</p> <p>Mode 1: Alarm can be independently triggered if any one of the event alarm conditions is met.</p> <p>Mode 2: Alarm can be triggered only when the number of people meets the alarm threshold and at least one person's waiting time meets the threshold.</p> |
| Heat Map | <p>A graphic description of visits (by calculating amount of people or amount of dwell time) in a configured area.,</p> <p>Two report types are available, space heat map and time heat map line chart.</p> |
| Metadata | Intrusion detection, line crossing detection, region entrance detection, region exiting detection, face capture, multi-target-type detection |

| | |
|----------------------------------|---|
| Regional People Counting | <p>Supports up to 8 detection regions, and independent arming schedule and linkage method</p> <p>Supports 3 detection modes: people density detection, number of people exception detection, waiting time exception detection</p> <p>Supports parameter settings: alarm times per exception, alarm interval, first alarm delay</p> <p>Supports searching real-time number of people</p> <p>People density detection: supports scheduled uploading, number of people change uploading, congestion level uploading</p> <p>Number of people exception detection: supports 6 alarm trigger conditions, including greater than threshold A, less than threshold A, equal to threshold A, not equal to threshold A, greater than threshold A and less than threshold B, less than threshold A or greater than threshold B (threshold A should be less than threshold B)</p> <p>Waiting time exception detection: supports 3 alarm trigger conditions, including greater than threshold A, less than threshold A, greater than threshold A and less than threshold B (threshold A should be less than threshold B)</p> |
| On/Off Duty Detection | <p>Supports up to 8 detection regions, and independent arming schedule and linkage method</p> <p>Supports 2 detection modes: absence detection, on/off duty detection</p> <p>Supports parameter settings: person on duty, absence duration</p> |
| AcuSeek | Support search for humans, license plates, vehicles, non-motorized vehicles, and animals and uploading the feature information. This function requires use with AcuSeek NVR/Servers. |
| PPE Detection | <p>Detects hard hat and reflective clothing, triggering alarm when not worn.</p> <p>Detects people not wearing hard hat. Supported hat colors: red, orange, yellow, blue, white, and others.</p> |
| General | |
| Power | <p>12 VDC \pm 20%, 1.25 A, max. 15.5 W, three-core terminal block, reverse polarity protection,</p> <p>24 VAC \pm 20%, 1.05 A, max. 15 W,</p> <p>PoE: IEEE 802.3at, Type 2, Class 4, 42.5 V to 57 V, 0.4 A to 0.3 A, max. 16.7 W</p> |
| Material | Base: metal, cover: metal |
| Dimension | \varnothing 144.3 mm \times 114.1 mm (\varnothing 5.7" \times 4.5") |
| Package Dimension | 244 mm \times 174 mm \times 173 mm (9.6" \times 6.9" \times 6.8") |
| Weight | Approx. 970 g (2.14 lb.) |
| With Package Weight | Approx. 1350 g (2.98 lb.) |
| Storage Conditions | -40 °C to 60 °C (-40 °F to 140 °F). Humidity 95% or less (non-condensing) |
| Startup and Operating Conditions | <p>With -H: -40 °C to 60 °C (-40 °F to 140 °F). Humidity 95% or less (non-condensing),</p> <p>Without -H: -30 °C to 65 °C (-22 °F to 149 °F). Humidity 95% or less (non-condensing)</p> |
| Language | <p>31 languages: English, Traditional Chinese, Bulgarian, Hungarian, Greek, German, Italian, Czech, Slovak, French, Polish, Dutch, Portuguese, Spanish, Russian, Japanese, Turkish, Korean, Thai, Estonian, Vietnamese, Romanian, Danish, Swedish, Norwegian, Finnish, Croatian, Slovenian, Serbian, Lithuanian, Ukrainian</p> |
| General Function | Heartbeat, one-key reset, mirror, password protection |
| Heater | -H: Yes |
| Device Management | Supports adding alarm box (DS-FM2466) in the LAN to expand 6 additional input and 6 output alarm interfaces. Supports adding network microphone and speaker. |

| | |
|----------------------------|--|
| Integrated Connector Panel | No |
| Approval | |
| EMC | CE-EMC: EN 55032:2015+A1:2020, EN 50130-4:2011+A1:2014, EN IEC 61000-3-2:2019+A1:2021, EN 61000-3-3:2013+A1:2019+A2:2021, RCM: AS/NZS CISPR 32: 2015, KC: KN32: 2015, KN35: 2015 |
| Safety | CB: IEC 62368-1:2014+A11, CE-LVD: EN 62368-1:2014/A11: 2017 |
| Environment | CE-RoHS: 2011/65/EU, WEEE: 2012/19/EU, Reach: Regulation (EC) No 1907/2006 |
| Protection | IP67:IEC 60529-2013,IK10:IEC 62262:2002 |
| Anti-Corrosion Protection | -Y: NEMA 4X (NEMA 250-2018) |
| Automotive and Railway | EN50121-4 |
| Other | PVC FREE |

▪ Typical Application

Hikvision products are classified into three levels according to their anti-corrosion performance. Refer to the following description to choose for your using environment.

-Y model: This model has MODERATE PROTECTION.

Without -Y model: This model has NO SPECIFIC PROTECTION.

| Level | Description |
|----------------------|--|
| Top-level protection | Hikvision products at this level are equipped for use in areas where professional anti-corrosion protection is a must. Typical application scenarios include coastlines, docks, chemical plants, |

| | |
|-------------------------------|--|
| <p>Moderate protection</p> | <p>and more. Hikvision products at this level are equipped for use in areas with moderate anti-corrosion demands. Typical application scenarios include coastal areas about 2 kilometers (1.24 miles) away from coastlines, as well as areas affected by acid rain.</p> |
| <p>No specific protection</p> | <p>Hikvision products at this level are equipped for use in areas where no specific anti-corrosion protection is needed.</p> |

▪ **Dimension**

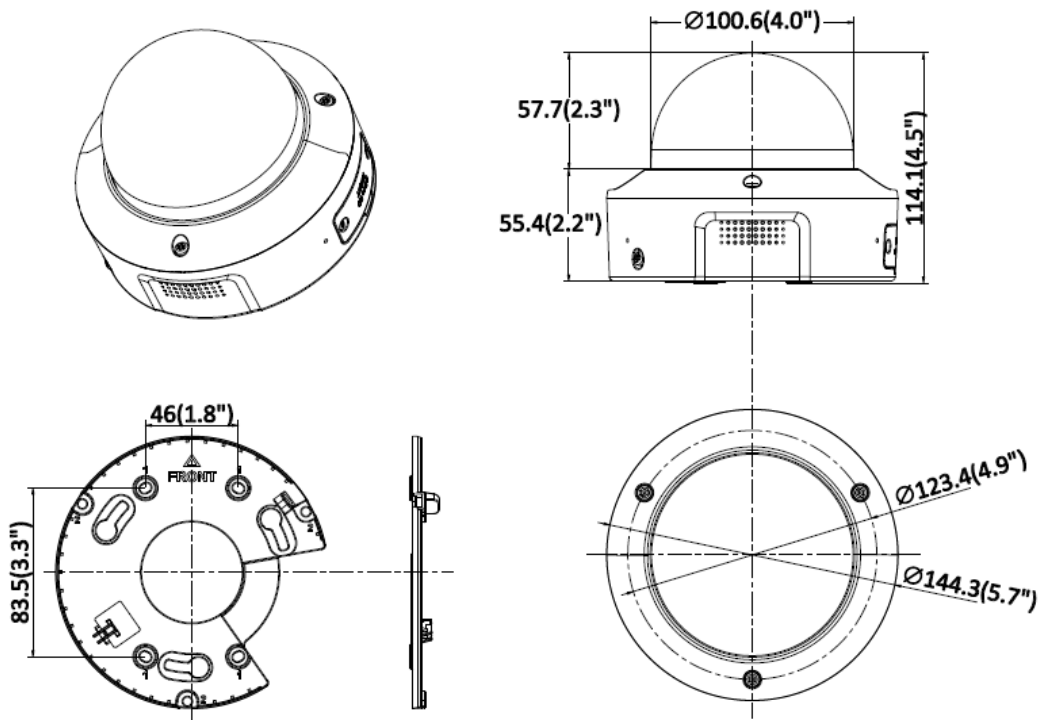

Unit:mm (inch)

| Camera Mounting Hole (mm) | Camera Mounting Hole (inch) |
|---------------------------|-----------------------------|
| Double Gang(4*φ4.5) | Double Gang(4*φ0.2") |





▪ Accessory

▪ Optional

| DS-2280ZJ-WA140 | DS-1475ZJ-SUS | DS-2200ZJ-WA-140 | DS-1476ZJ-SUS | DS-2200ZJ-WAJ-140 |
|---|---|---|---|---|
|  |  |  |  |  |
| DS-1273ZJ-160-AK S | DS-1281ZJ-DM23 | DS-1476ZJ-Y | DS-2210ZJ-WA-140 | DS-4220ZJ-WC |

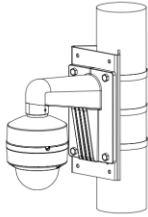
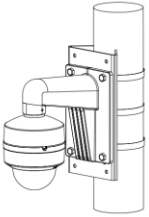
| | | | | |
|---|---|---|---|---|
|  |  |  |  |  |
| DS-1271ZJ-140-DM 45 | DS-1227ZJ-DM32 | DS-1475ZJ-Y | | |
|  |  |  | | |

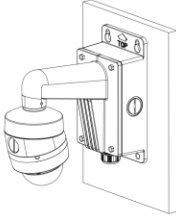
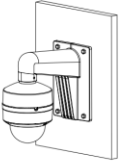
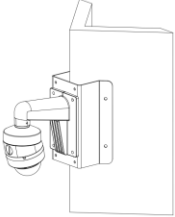
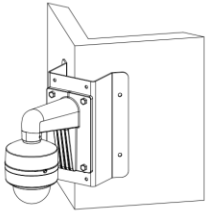
▪ **Installation Methods**

| | | | | |
|---|---|---|--|---|
| Junction Box DS-2280ZJ-WA140 | Vertical Pole Mounting DS-1475ZJ-SUS+DS-2200ZJ-WA-140 | Vertical Pole Mounting DS-1475ZJ-Y+DS-1273 ZJ-160-AKS | Wall Mounting DS-2200ZJ-WA-140+D S-1253ZJ-L | Wall Mounting DS-2200ZJ-WAJ-140+ DS-1281ZJ-DM23 |
|  |  |  |  |  |
| Wall Mounting DS-1273ZJ-160-AKS | Corner Mounting DS-1476ZJ-SUS+DS-1281ZJ-DM23+DS-2200ZJ-WA-140 | Corner Mounting DS-1476ZJ-Y+DS-1273 ZJ-160-AKS | Inclined Ceiling Mounting DS-1281ZJ-DM23 | Pendant Mounting DS-2210ZJ-WA-140 |
|  |  |  |  |  |
| Pendant Mounting DS-1271ZJ-140-DM45 | In-Ceiling Mounting DS-4220ZJ-WC | In-Ceiling Mounting DS-1227ZJ-DM32 | | |

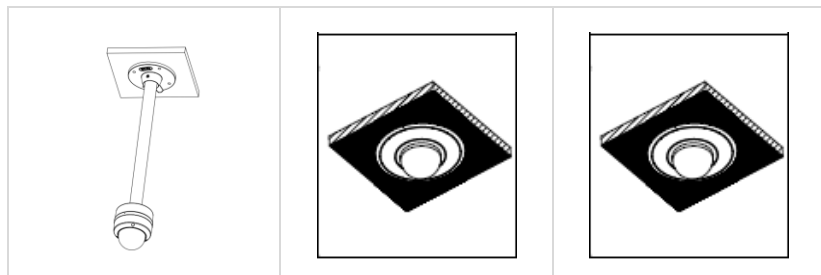

See Far, Go Further



www.hikvision.com
support@hikvision.com

