

DS-K1T673DGX-E1 Face Recognition Terminal



Face recognition terminal is a kind of access control device. It can be widely applied in multiple scenarios, such as enterprises, stations, dwellings, factories, schools, campus and so on.

- 7-inch LCD touch screen, 2 Mega pixel wide-angle lens
- Recognition distance: 0.3 to 3 m
- Face recognition duration < 0.2 s/User
- Face recognition accuracy rate ≥ 99%
- Built-in M1 card, Felica card, and DESfire card reading module (Presents card on the screen to authenticate)
- Face mask detection
- 10,000 face capacity, 10,000 fingerprint capacity (With fingerprint module), 50,000 card capacity, and 150,000 event capacity
- Supports ISAPI, ISUP 5.0, TCP/IP (IPv4 and IPv6), 3G/4G
- Supports single person and multiple people (Up to 5 people) recognition
- Supports Push SDK.
- Supports face duplicate check, preventing multiple people from using the same face.
- Supports the following SIP servers: ASTERISK, 3CX, ELASTIX, miniSipServer, Brekeke, OpenSIPs, Kamailio.
- Supports attendance-only function.
- Supports customized Wiegand parameters.

▪ Specification

System	
ROM	4 GB
RAM	1 GB
Operation system	Linux
Display	
Operation method	Capacitive touch screen
Resolution	600 × 1024
Size	7-inch
Type	Touch screen
Video	
FOV	HFOV= 75.5°; VFOV= 41.5°; DFOV= 87°
Focal length	4 mm
Aperture	F1.1
Pixel	2 MP
Lens	Dual-lens
WDR	Support
Video standard	PAL (Default)/NTSC
Audio	
Audio compression standard	G.711U
Audio compression bitrate	64 Kbps
Tone quality	Built-in omnidirectional microphone
Volume adjustment	Support
Power output	1.5 W
Network	
Network protocol	
4G	Support
Interface	
Alarm input	2
Alarm output	1
USB	1 (For Module)
Audio Output Interface	1 (3.5 mm)
PoE	Support, IEEE802.3at
Network interface	1
RS-485	1 RS-485. Supports OSDP protocol version V2.1.7, Baud 19200
Wiegand	1
Lock output	1
Exit button	1
Door contact input	1
TAMPER	1
Capacity	
Fingerprint capacity	10,000 (With fingerprint module)
Card capacity	50,000
Face capacity	10,000
Event capacity	150,000

Authentication	
Face recognition accuracy rate	≥ 99%
Card type	M1 card,DESfire card,Felica card
Frequency Band	LTE-FDD: B1/B3/B5/B7/B8/B20/B28 LTE-TDD: B38/B40/B41 WCDMA: B1/B5/B8 GSM/EDGE: B3/B8
Card reading distance	0 to 3 cm
Card reading duration	< 1 s
Face recognition duration	< 0.2 s per person
Face recognition distance	0.3 to 3 m
General	
Indicator	Support
Power supply	12 VDC to 24 VDC/2 A
Working temperature	-30 °C to 60 °C (-22 °F to 140 °F)
Working humidity	0 to 90% (no condensing)
Protective level	IP65
Dimensions	110.5 mm × 209.2 mm × 24 mm (4.35" × 8.24" × 0.94")
Language	English, Spanish (South America), Arabic, Thai, Indonesian, Russian, Vietnamese, Brazilian Portuguese, Japanese, Korean, Chinese Traditional, French, Turkish, Kazakh and Uzbek.
Weight	Gross Weight : 1.06 kg (2.34 lb) Net Weight : 0.57 kg (1.26 lb)
Power Output	DC 12 V, 0.5 A
Function	
Two-way audio	Support
Multi-factor authentication	Support
M1 card encryption	Support
Anti-passback	Support
First person in	Support
Advertisement	Support
Time synchronization	Support
Face anti-spoofing	Support
Live view	Support
Audio prompt	Support



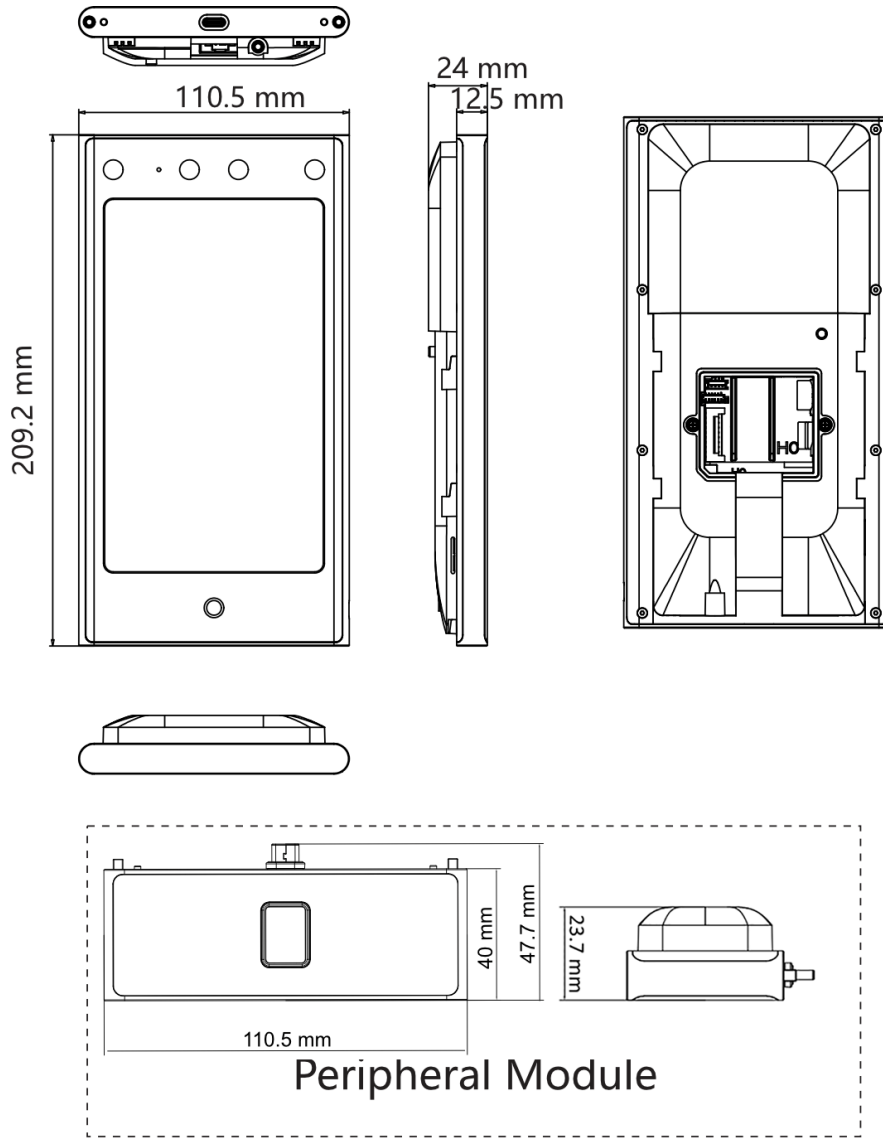





▪ Dimension



▪ **Accessory**

▪ **Optional**

DS-KAB673-SF1	DS-KAB673-S1	DS-KAB6-ZU2	DS-KAB673-A	DS-KAB673-FBQR
DS-KAB6-ZU1	DS-KAB673-FB	DS-KAB673-P	DS-KAB673-B	DS-KAB6-D1

				
DS-KAB673-EDB	DS-KAB673-BQR	DS-KAB6-ZU3	DS-KAB6-W1	
				

See Far, Go Further



www.hikvision.com
support@hikvision.com

