

DS-2XE6046G0-LIS(ADC) Aluminum Alloy 4MP Explosion-Proof Fixed Bullet

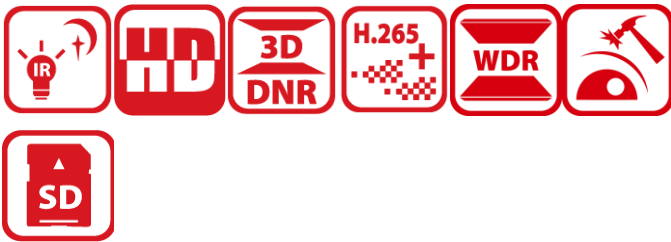

- Explosion-proof design: the camera has passed international ATEX & IECEx certifications, and can be used in gas and dust hazardous scenarios
- IP68 water resistant, preventing water ingress for outdoor use
- H.265+/H.265/H.264+/H.264 encoding: efficient compression technology saves storage space and reduces bandwidth requirements
- Vandal resistant (IK10)

▪ Specification

Camera	
Image Sensor	1/2.7" Progressive Scan CMOS
Max. Resolution	2560 × 1440
Min. Illumination	Color: 0.005 Lux @ (F1.6, AGC ON), 0 Lux with light
Shutter Time	1/3 s to 1/100,000 s
Day & Night	IR cut filter
Lens	
Focal Length & FOV	2.8 mm, horizontal FOV 103.6°, vertical FOV 57.2°, diagonal FOV 121.6° 4 mm, horizontal FOV 83.5°, vertical FOV 44.8°, diagonal FOV 99.9° 6 mm, horizontal FOV 51.8°, vertical FOV 27.9°, diagonal FOV 60.5°
Aperture	F1.6
Illuminator	
Supplement Light Type	IR, White Light
Supplement Light Range	IR: up to 50 m White Light: up to 30 m
IR Wavelength	850 nm
Video	
Main Stream	50 Hz: 25 fps (2560 × 1440, 1920 × 1080, 1280 × 720) 60 Hz: 30 fps (2560 × 1440, 1920 × 1080, 1280 × 720)
Sub-Stream	50 Hz: 25 fps (1280 × 720, 640 × 480, 640 × 360) 60 Hz: 30 fps (1280 × 720, 640 × 480, 640 × 360)
Video Compression	Main stream: H.265+/H.265/H.264+/H.264, Sub-stream: H.265/H.264/MJPEG
Video Bit Rate	32 Kbps to 8 Mbps
H.264 Type	Baseline Profile, Main Profile, High Profile
H.265 Type	Main Profile
Scalable Video Coding (SVC)	H.264 and H.265 encoding
Region of Interest (ROI)	1 fixed region for main stream
Audio	
Audio Compression	G.711/G.722.1/G.726/MP2L2/PCM/AAC-LC
Audio Bit Rate	64 Kbps (G.711ulaw/G.711alaw)/16 Kbps (G.722.1)/16 Kbps (G.726)/32 to 192 Kbps (MP2L2)/16 to 64 Kbps (AAC-LC)
Audio Sampling Rate	8 kHz/16 kHz
Environment Noise Filtering	Yes
Network	
Protocols	SSL/TLS, RTSP, TCP/IP, RTP, HTTP, QoS, PPPoE, ICMP, DDNS, UDP, UPnP, IGMP, DHCP, DNS, SNMP, IPv4, IPv6, FTP, HTTPS, 802.1X, NTP
Simultaneous Live View	Up to 6 channels
API	ONVIF (Profile S, Profile G), ISAPI, SDK, ISUP
User/Host	Up to 32 users 3 user levels: administrator, operator, and user
Security	Password protection, complicated password, HTTPS encryption, 802.1X authentication (EAP-MD5), WSSE and digest authentication for ONVIF, basic and digest authentication for HTTP/HTTPSF, RTP/RTSP over HTTPS, security audit log, control timeout settings
Client	iVMS-4200, Hik-Connect, Hik-Central

Web Browser	Plug-in free live view: Chrome 80+, Firefox 80+, Edge 89+, Safari 13+
Image	
Image Settings	Rotate mode, saturation, brightness, contrast, sharpness, gain, white balance, adjustable by client software or web browser
Day/Night Switch	Day, Night, Auto, Schedule
Wide Dynamic Range (WDR)	120 dB
Image Enhancement	BLC, HLC, 3D DNR
Privacy Mask	4 programmable polygon privacy masks
Picture Overlay	LOGO picture can be overlaid on video with 128 × 128 24 bit bmp format.
Interface	
Ethernet Interface	1 RJ45 10 M/100 M self-adaptive Ethernet port
On-Board Storage	Built-in memory card slot, support microSD/microSDHC/microSDXC card, up to 256 GB, *You are recommended to purchase memory card together with the product if needed. After ordering, the memory card will be installed to product during manufacturing.
Audio	1 input (line in), two-core terminal block, max. input amplitude: 3.3 Vpp, input impedance: 4.7 KΩ, interface type: non-equilibrium, 1 output (line out), two-core terminal block, max. output amplitude: 3.3 Vpp, output impedance: 100 Ω, interface type: non-equilibrium
Alarm	1 input, 1 output (max. 5 VDC, 0.1 A)
Event	
Basic Event	Motion detection, video tampering alarm, exception (network disconnected, IP address conflict, illegal login, HDD full, HDD error), alarm input and output
Smart Event	Line crossing detection, intrusion detection, region entrance detection, region exiting detection, unattended baggage detection, object removal detection, scene change detection, audio exception detection
Linkage	Upload to FTP, notify surveillance center, send email, trigger recording, trigger capture, trigger alarm output, audible warning
General	
Power	100 VAC to 240 VAC, 0.2 A, max. 7 W, three-core terminal block, PoE: IEEE 802.3af, Class 3, max. 7 W
Material	Anodized ADC12
Dimension	243.6 mm × 194.8 mm × 184 mm (9.6" × 7.7" × 7.2")
Package Dimension	430 mm × 250 mm × 275 mm (16.93" × 9.84" × 10.83")
Weight	Approx. 3300 g (7.28 lb.)
With Package Weight	Approx. 4400 g (9.70 lb.)
Startup and Operating Conditions	-30 °C to 60 °C (-22 °F to 140 °F). Humidity 95% or less (non-condensing)
Language	9 languages: English, Italian, French, Portuguese, Spanish, Russian, Japanese, Korean, Thai
General Function	Heartbeat, mirror, flash log, password reset via e-mail, pixel counter, anti-banding
Cable Length	1.3 m or 5 m (4.26 ft. or 16.40 ft.)

Approval	
EMC	CE-EMC: EN 55032:2015+A1:2020, EN 50130-4:2011+A1:2014, EN IEC 61000-3-2:2019+A1:2021, EN 61000-3-3:2013+A1:2019+A2:2021, RCM: AS/NZS CISPR 32: 2015, IC: ICES-003: Issue 7, KC: KN32: 2015, KN35: 2015
Safety	CB: IEC 62368-1:2014+A11, CE-LVD: EN 62368-1:2014/A11: 2017, BIS: IS 13252 (Part1): 2010/IEC 60950-1:2005, LOA: IEC/EN 60950-1
Protection	IP68: IEC 60529-2013, IK10: IEC 62262:2002
Explosion-Proof Protection	ATEX: Ex II 2 G D Ex db IIC T6 Gb/Ex tb IIIC T80 °C Db IP68 IECEx: Ex db IIC T6 Gb/Ex tb IIIC T80 °C Db IP68 For explosive gas atmospheres, the maximum surface temperature is 85 °C; For flammable dust atmospheres, the maximum surface temperature is 80 °C; IIC: for explosive gas atmospheres other than mines susceptible to firedamp; For explosive gas mixture atmospheres: Zone 1, Zone 2, Zone 21, Zone 22.

▪ Typical Application

Hikvision products are classified into three levels according to their anti-corrosion performance. Refer to the following description to choose for your using environment.

This model has no specific protection.

Level	Description
Top-level protection	Hikvision products at this level are equipped for use in areas where professional anti-corrosion protection is a must. Typical application scenarios include coastlines, docks, chemical plants, and more.
Moderate protection	Hikvision products at this level are equipped for use in areas with moderate anti-corrosion demands. Typical application scenarios include coastal areas about 2 kilometers (1.24 miles) away from coastlines, as well as areas affected by acid rain.
No specific protection	Hikvision products at this level are equipped for use in areas where no specific anti-corrosion protection is needed.

▪ Available Model

DS-2XE6046G0-LIS(ADC)(2.8mm)1.3m

DS-2XE6046G0-LIS(ADC)(2.8mm)5m

DS-2XE6046G0-LIS(ADC)(4mm)1.3m

DS-2XE6046G0-LIS(ADC)(4mm)5m

DS-2XE6046G0-LIS(ADC)(6mm)1.3m

DS-2XE6046G0-LIS(ADC)(6mm)5m

▪ Dimension

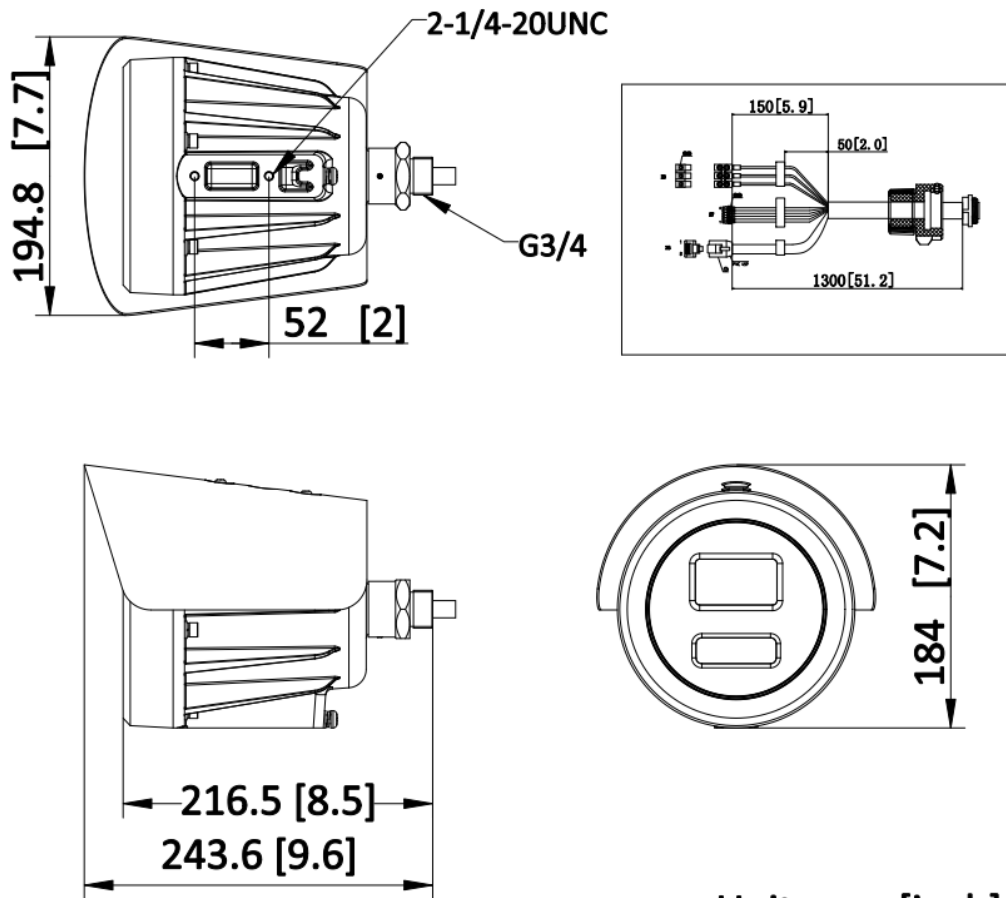





Unit: mm [inch]

SCALE	1:1
-------	-----

▪ Accessory

▪ Optional

DS-2XE2601-1(CS)	DS-2XE2702-M04(A DC)	DS-1275ZJ-SUS	DS-2XE2601-5(CS)	DS-2XE2703-M06(A DC)
				
DS-1293ZJ-P-Y	DS-1269ZJ-P-Y			



See Far, Go Further



www.hikvision.com
support@hikvision.com

