

DS-2SE7C432IWG-K/4G/14(F0)

TandemVu 7-inch 4MP 32x Solar-powered Security Network Speed Dome Kit

ColorVu



Hikvision DS-2SE7C432IWG-4G/14(F0) 4 MP 32 × IR Network Speed Dome adopts 1/1.8" progressive scan CMOS chip. With the 32 × optical zoom lens, the camera offers more details over expansive areas. This series of cameras can be widely used for wide ranges of high-definition, such as rivers, roads, railways, airports, squares, parks, scenic spots, and venues, etc. Hikvision has been dedicated to develop products with security since established. Hikvision always follows security by design principle and has adopted many methods of security technologies into our product development lifecycle, including terminal security, data security, application security, network security, and privacy protection. In the meantime, the security technologies used by Hikvision are all in compliance with local applicable laws and safety regulations. These security measures could enhance product's cyber security protection capability and protect your devices as well as your data from malicious cyber attacks.

- Captures a large area and great details at the same time
- High quality imaging with 4 MP resolution
- Excellent low-light performance with ColorVu technology in bullet channel
- Secures an expansive area with 32 × optical zoom and 16 × digital zoom
- Supports WDR, HLC, BLC, 3D DNR, defog, regional exposure, regional focus
- Expansive night view with up to 30 m IR distance in bullet channel, and 200 m IR distance in PTZ channel
- Supports 12 VDC output
- Supports scheduled sleep mode and low power sleep mode. The consumption reaches 0.5 W in sleep mode.

▪ Specification

Camera	
Image Sensor	[Bullet channel] 1/1.8" Progressive Scan CMOS, [PTZ channel] 1/1.8" Progressive Scan CMOS
Max. Resolution	[Bullet channel] 2560 × 1440, [PTZ channel] 2560 × 1440
Min. Illumination	[Bullet channel]: 0.0005 Lux @ (F1.0, AGC ON), 0 Lux with light; [PTZ channel]: Color: 0.005 Lux @ (F1.5, AGC ON), B/W: 0.001 Lux @ (F1.5, AGC ON), 0 Lux with IR
Shutter Speed	1 s to 1/30,000 s
Day & Night	ICR
Zoom	[PTZ channel] 32 × optical, 16 × digital
Slow Shutter	Yes
Lens	
Focal Length	[Bullet channel] 2.8 mm, [PTZ channel] 5.9 to 188.8 mm mm
FOV	[Bullet channel] horizontal field of view: 108°, vertical field of view: 56°, diagonal field of view: 134°, [PTZ channel] horizontal field of view: 60.2° to 2.3°, vertical field of view: 35.2° to 1.3°, diagonal field of view: 67.4° to 2.6°
Focus	Auto,semi-auto,manual
Aperture	[Bullet channel]: F1.0; [PTZ channel]: F1.5
Zoom Speed	[PTZ channel]: approx. 5.6 s
Illuminator	
Supplement Light Type	[Bullet channel] IR, [PTZ channel] IR
Supplement Light Range	[Bullet channel] IR: up to 30 m, [PTZ channel] IR: up to 200 m
Smart Supplement Light	Yes
PTZ	
Movement Range (Pan)	360°
Movement Range (Tilt)	-15° to 90°
Pan Speed	Pan speed: configurable from 0.1° to 80°/s, preset speed: 80°/s
Tilt Speed	Tilt speed: configurable from 0.1° to 80°/s, preset speed 80°/s
Proportional Pan	Yes
Presets	300
Preset Freezing	Yes
Patrol Scan	8 patrols, up to 32 presets for each patrol
Pattern Scan	4 pattern scans, record time over 10 minutes for each scan
Park Action	Preset,patrol scan
3D Positioning	Yes
PTZ Status Display	Yes
Scheduled Task	Preset,patrol scan,dome reboot,aux output,dome adjust
Power-off Memory	Yes
Video	
Main Stream	[Bullet channel] 50 Hz: 25 fps (2560 × 1440, 1920 × 1080, 1280 × 960, 1280 × 720), 60 Hz: 30 fps (2560 × 1440, 1920 × 1080, 1280 × 960, 1280 × 720),[PTZ channel] 50 Hz: 25 fps (2560 × 1440, 1920 × 1080, 1280 × 960, 1280 × 720), 60 Hz: 24 fps (2560 × 1440, 1920 × 1080, 1280 × 960, 1280 × 720)

Sub-Stream	[Bullet channel] 50 Hz: 25 fps (704 × 576, 640 × 480, 352 × 288), 60 Hz: 30 fps (704 × 480, 640 × 480, 352 × 240), [PTZ channel] 50 Hz: 25 fps (704 × 576, 640 × 480, 352 × 288), 60 Hz: 24 fps (704 × 480, 640 × 480, 352 × 240)
Third Stream	[Bullet channel] 50 Hz: 25 fps (1920 × 1080, 1280 × 960, 1280 × 720, 704 × 576, 640 × 480, 352 × 288), 60 Hz: 30 fps (1920 × 1080, 1280 × 960, 1280 × 720, 704 × 480, 640 × 480, 352 × 240), [PTZ channel] 50 Hz: 25 fps (1920 × 1080, 1280 × 960, 1280 × 720, 704 × 576, 640 × 480, 352 × 288), 60 Hz: 24 fps (1920 × 1080, 1280 × 960, 1280 × 720, 704 × 480, 640 × 480, 352 × 240)
Video Compression	Main stream: H.265+/H.265/H.264+/H.264, Sub-stream: H.265/H.264/MJPEG, Third stream: H.265/H.264/MJPEG
Video Bit Rate	32 Kbps to 16 Mbps
H.264 Type	Baseline profile, Main profile, High profile
H.265 Type	Main profile
Scalable Video Coding (SVC)	H.264 and H.265 encoding
Region of Interest (ROI)	8 fixed regions for each stream
Audio	
Audio Compression	G.711, G.722.1, G.726, MP2L2, PCM, MP3, AAC-LC
Audio Bit Rate	MP2L2: 32 kbps, 40 kbps, 48 kbps, 56 kbps, 64 kbps, 80 kbps, 96 kbps, 112 kbps, 128 kbps, 144 kbps, 160 kbps, 192 kbps AAC-LC: 16 kbps, 32 kbps, 64 kbps MP3: 8 kbps, 16 kbps, 24 kbps, 32 kbps, 40 kbps, 48 kbps, 56 kbps, 64 kbps, 80 kbps, 96 kbps, 112 kbps, 128 kbps, 144 kbps, 160 kbps, 192 kbps, 224 kbps, 256 kbps, 320 kbps
Audio Sampling Rate	AAC-LC: 16 kHz, 32 kHz, 48 kHz, MP2L2: 16 kHz, 32 kHz, 48 kHz, PCM: 8 kHz, 16 kHz, 32 kHz, 48 kHz, MP3: 8 kHz, 16 kHz, 32 kHz, 48 kHz
Environment Noise Filtering	Yes
Network	
Protocols	TCP/IP, ICMP, HTTP, HTTPS, 802.1X, QoS, FTP, SMTP, UPnP, SNMP, DNS, DDNS, NTP, RTSP, RTP, P, RTP, UDP, IPv4/IPv6, IGMP, DHCP, Bonjour, WebSocket, WebSockets
Simultaneous Live View	20
API	ISAPI, ISUP, SDK
User/Host	32
Security	Password protection, complicated password, HTTPS encryption, 802.1X authentication (EAP-TLS, EAP-LEAP, EAP-MD5), IP address filter
Network Storage	NAS (NFS, SMB/ CIFS), ANR
Client	iVMS-4200, Hik-Connect
Web Browser	IE 10+, Chrome 57+, Firefox 52+, Safari 12+
Wireless (Mobile Communication)	
Mobile Communication Type	4G

Frequency	<p>LTE FDD/WCDMA: B1</p> <p>LTE FDD/GSM: B3</p> <p>LTE FDD/WCDMA/GSM: B5/B7</p> <p>LTE FDD: B7/B20/B28</p> <p>LTE TDD: B38/B40/B41;</p> <p>LTE FDD/WCDMA: B1/B4</p> <p>LTE FDD/WCDMA/GSM: B2/B3/B5/B8</p> <p>LTE FDD: B12/B17/B28/B66</p> <p>LTE TDD: B38/B40;</p> <p>LTE FDD/WCDMA: B1/B8</p> <p>LTE FDD: B3/B11/B18/B19/B21/B26/B28</p> <p>LTE TDD: B41</p>
Standard	<p>LTE FDD/WCDMA</p> <p>LTE FDD/GSM</p> <p>LTE FDD/WCDMA/GSM</p> <p>LTE FDD</p> <p>LTE TDD</p>
Image	
Image Parameters Switch	Yes
Image Settings	Saturation, brightness, contrast, sharpness
Day/Night Switch	day, night, auto, scheduled-switch
Wide Dynamic Range (WDR)	120 dB WDR
SNR	> 52dB
Defog	Yes
Image Stabilization	EIS (Built-in gyroscope to improve EIS performance)
Image Enhancement	BLC, HLC, 3D DNR
Regional Focus	Yes
Regional Exposure	Yes
Interface	
Ethernet Interface	RJ45, self-adaptive 10M/100M Ethernet port
On-board Storage	Built-in memory card slot, support Micro SD/Micro SDHC/Micro SDXC, up to 256 GB
Audio	1 input (line in), max. input amplitude: 2-2.4 vpp, input impedance: 1 K Ω \pm 10%, 1 output (line out), line level, output impedance: 600 Ω
Alarm	2 input(s), 1 output(s)
Reset	Yes
Power Output	12 VDC, max. 1000 mA
Event	
Basic Event	[PTZ channel] motion detection, video tampering alarm, [PTZ channel & bullet channel] alarm input and output, exception
Smart Event	[PTZ channel] line crossing detection, intrusion detection, region entrance detection, region exiting detection
Linkage	[Bullet channel] Upload to FTP/NAS/memory card, notify surveillance center, send email, trigger alarm output, and trigger recording, [PTZ channel] Upload to FTP/NAS/memory card, notify surveillance center, send email, trigger alarm output, trigger recording, and PTZ actions (such as preset, patrol scan, pattern scan)
Smart Tracking	[PTZ channel] Yes

Smart Linkage	Manual tracking, auto tracking, tracking takeover, track in turn
Deep Learning Function	
Face Capture	[Bullet channel] no,[PTZ channel] Yes
General	
Power	12 VDC \pm 25%, max. 28 W,Typical power scenarios:8.7 W (4G working); Standby scenarios: 7.7W (4G working); Sleep mode: 100 mW
Dimension	\varnothing 220 mm \times 382.1 mm (\varnothing 8.66" \times 15.04")
Weight	Approx. 6 kg (13.23 lb.)
Material	ADC12
Operating Condition	-30 $^{\circ}$ C to 65 $^{\circ}$ C (-22 $^{\circ}$ F to 149 $^{\circ}$ F). Humidity 90% or less (non-condensing)
General Function	mirror,password protection,watermark,IP address filter
Demist	Demist by heating the glass
Battery	
Battery Type	Lithium
Battery Voltage	9 to 12.6 V
Capacity	360 WH (90 WH for each battery)
Max. Charging Voltage	12.6 V
Operating Temperature	Charging: -20 $^{\circ}$ C to 45 $^{\circ}$ C (-4 $^{\circ}$ F to 113 $^{\circ}$ F) Discharging: -20 $^{\circ}$ C to 60 $^{\circ}$ C (-4 $^{\circ}$ F to 140 $^{\circ}$ F)
Cycle Lifetime	Performance mode: 1.5 days. Proactive mode: 2 days. Standby mode: 80 days *in cloudy/rainy days (25 $^{\circ}$ C)
Battery Life	More than 500 cycles
Battery Weight	Approx. 2.74 kg (6.0 lb.) (0.685 kg (1.5 lb.) for each battery)
Approval	
Protection	IP67 (IEC 60529-2013),IK10 (IEC 62262:2002),TVS 6000 V lightning protection, surge protection and voltage transient protection
Solar	
Solar Panel Type	Polycrystalline Glass Solar Panel
Conversion Efficiency	18.5%
Power Consumption	80W(\pm 5%)/19.18V/4.19A
Solar Panel Dimensions & Weight	760(\pm 0.5) \times 644(\pm 0.5) \times 25(\pm 0.3) mm,5.8KG

▪ DORI

The DORI (detect, observe, recognize, identify) distance gives the general idea of the camera ability to distinguish persons or objects within its field of view. It is calculated based on the camera sensor specification and the criteria given by EN 62676-4: 2015.

DORI	Detect	Observe	Recognize	Identify
Definition	25 px/m	63 px/m	125 px/m	250 px/m
Distance (Tele)	3060.0 m (10039.4 ft)	1214.3 m (3983.9 ft)	612.0 m (2007.9 ft)	306.0 m (1004.0ft)

▪ Typical Application

Hikvision products are classified into three levels according to their anti-corrosion performance. Refer to the following description to choose for your using environment.

This model has NO SPECIFIC PROTECTION.

Level	Description
Top-level protection	Hikvision products at this level are equipped for use in areas where professional anti-corrosion protection is a must. Typical application scenarios include coastlines, docks, chemical plants, and more.
Moderate protection	Hikvision products at this level are equipped for use in areas with moderate anti-corrosion demands. Typical application scenarios include coastal areas about 2 kilometers (1.24 miles) away from coastlines, as well as areas affected by acid rain.
No specific protection	Hikvision products at this level are equipped for use in areas where no specific anti-corrosion protection is needed.

▪ Dimension

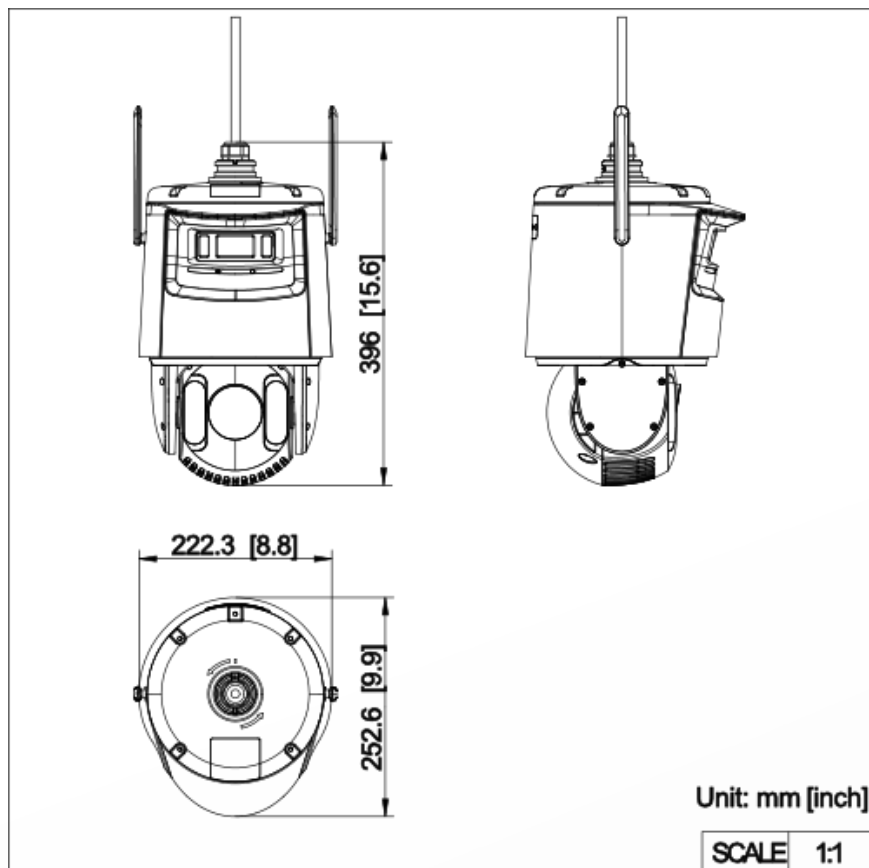

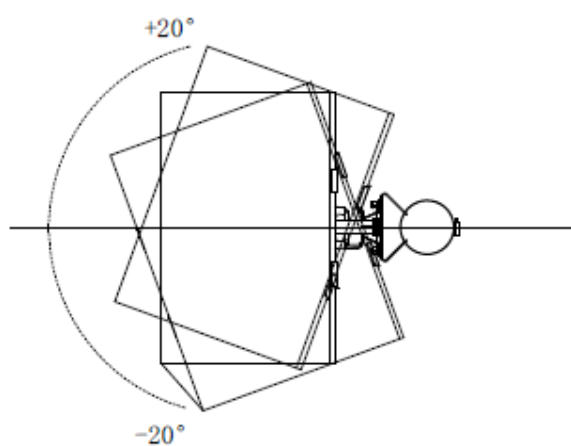
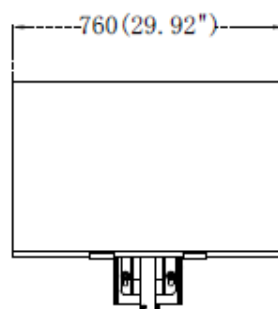
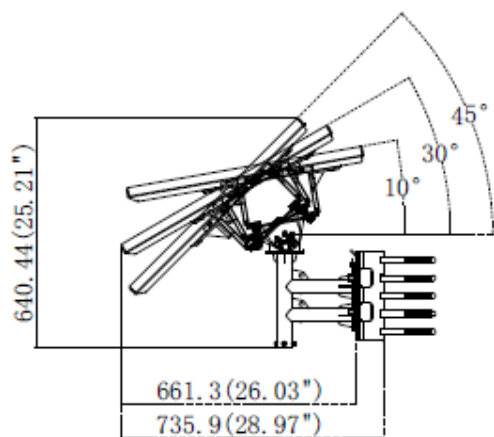

Pole Mount

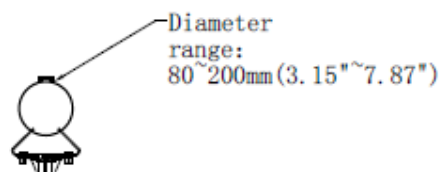





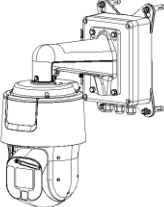
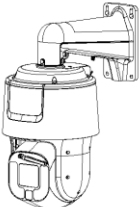
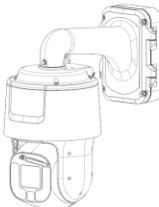

▪ **Accessory**

▪ **Optional**

DS-1604ZJ-box	DS-1673ZJ	DS-1663ZJ	DS-1619ZJ	DS-4660ZJ-WC
				
DS-1604ZJ-pole	DS-1604ZJ-BOX-POLE	DS-1667ZJ	DS-1604ZJ-corner	DS-1661ZJ
				
DS-1602ZJ	DS-1276ZJ	DS-1674ZJ	DS-1684ZJ	DS-1660ZJ
				
DS-1604ZJ	DS-1604ZJ-BOX-CORNER	DS-1662ZJ	DS-4650ZJ-WC	
				

▪ **Installation Methods**

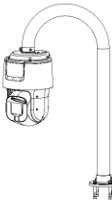
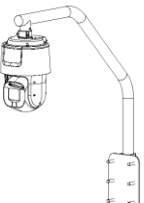
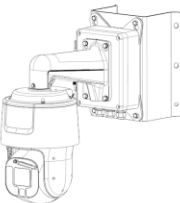
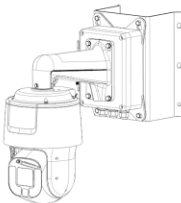
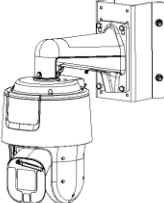
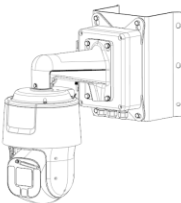
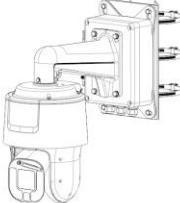
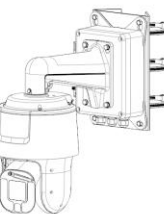
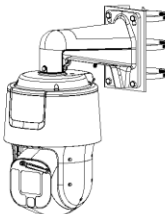
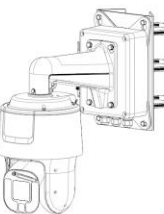
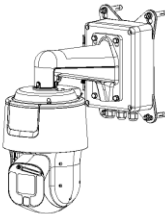
<p>Wall Mounting DS-1604ZJ-box</p>	<p>Wall Mounting DS-1602ZJ</p>	<p>Wall Mounting DS-1604ZJ</p>	<p>Horizontal Pole Mounting DS-1673ZJ+DS-1661ZJ</p>	<p>Pendant Mounting DS-1663ZJ</p>
				
<p>Pendant Mounting DS-1667ZJ</p>	<p>Pendant Mounting DS-1661ZJ</p>	<p>Pendant Mounting DS-1662ZJ</p>	<p>Gooseneck Mounting DS-1619ZJ</p>	<p>Gooseneck Mounting DS-1660ZJ</p>
				
<p>Corner Mounting DS-4660ZJ-WC+DS-1602ZJ+DS-1674ZJ</p>	<p>Corner Mounting DS-1604ZJ-corner</p>	<p>Corner Mounting DS-1276ZJ+DS-1602ZJ</p>	<p>Corner Mounting DS-1604ZJ-BOX-CORN ER</p>	<p>Vertical Pole Mounting DS-1604ZJ-pole</p>
				
<p>Vertical Pole Mounting DS-1604ZJ-BOX-POLE</p>	<p>Vertical Pole Mounting DS-1684ZJ+DS-1602ZJ</p>	<p>Vertical Pole Mounting DS-4650ZJ-WC+DS-1674ZJ+DS-1602ZJ</p>	<p>Junction Box DS-1674ZJ+DS-1602ZJ</p>	
				

See Far, Go Further



www.hikvision.com
support@hikvision.com

