

DS-K1T342MWX-E1 Face Recognition Terminal

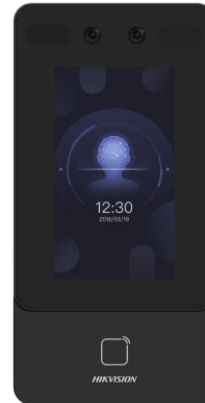

Face recognition terminal adopts deep learning algorithm, which helps to recognize the face faster with higher accuracy. It also supports multiple authentication modes: face/card authentication, etc. It can be applied in multiple scenarios, such as buildings, enterprises, financial industries, and other important areas.

- Max.1500 faces capacity, and Max.3000 cards
- Face Recognition Terminal, 4.3-inch LCD touch screen, 2 Mega pixel wide-angle lens, built-in M1 card reading module
- Two-way audio with client software, indoor station, and main station; Supports TCP/IP, Wi-Fi
- Supports ISAPI, ISUP5.0
- Configuration via the web client
- Face Recognition Distance: 0.3 m to 1.5 m; Duration < 0.2 s/User; Accuracy rate ≥ 99%
- Supports face with mask recognition
- Powers supply by standard PoE and at the same time powers supply for door lock (12 VDC/1 A)
- Supports platform-applied personal PIN and device-set personal PIN
- Supports Push SDK.
- Supports the following SIP servers: ASTERISK, 3CX, ELASTIX, miniSipServer, Brekeke, OpenSIPs, Kamailio.
- Supports face duplicate check, preventing multiple people from using the same face.
- Supports attendance-only function.

▪ Specification

Model		DS-K1T342MWX-E1		
System	CPU	900 MHz		
	Memory	DDR3:512 M		
	Flash	4 GB		
	Operation system	Linux		
Display	Dimensions	4.3-inch		
	Resolution	272 × 480		
	Type	LCD		
	Operation method	Capacitive touch screen		
	Lumens	250cd		
Video	Pixel	2 MP		
	Lens	× 2		
	Focal length	4 mm		
	WDR	Support		
	Aperture	F2.0		
	HOV	HFOV: 75.5°;	VFOV: 41.5°;	DFOV: 87°
	Video standard	PAL (Default) and NTSC		
Audio	Audio input	Built-in omnidirectional microphone		
	Audio output	Built-in loudspeaker		
	Volume adjustment	Adjust via device or client		
	Power output	8 Ω, 1.5 W		
	Audio compression standard	G.711U		
	Audio compression bitrate	64 Kbps		
	Tone quality	Noise suppression and echo cancellation		
Network	Wired network	10 M/100 M self-adaptive		
	Wi-Fi	Support		
	Communication protocol	ISAPI, ISUP5.0		
Interface	PoE	IEEE802.3at, standard PoE		
	Network interface	1		
	RS-485	1		
	Wiegand	1		
	Lock output	1		
	Exit button	1		

	Door contact input	1
	TAMPER	1
	USB	1
Capacity	User capacity	1500
	Card capacity	3,000
	Face capacity	1,500
	Event capacity	150,000
Authentication	Card type	M1 card
	Card reading frequency	13.56 MHz
	Card reading distance	0 to 3 cm (Normal Card); 0 to 2 cm (Card with Different Shapes)
	Card reading duration	< 1 s
	Face recognition duration	< 0.2 s
	Face recognition accuracy rate	> 99%
	Face recognition distance	0.3 to 1.5 m
General	button	Touch Screen
	Supplement light	IR light
	Power supply	Power input: Power interface (power adapter included, 12 VDC/1 A) or PoE (37 to 57 VDC/0.6 A) Power output: Power supply for door lock, 12 VDC/1 A (only when the device is powered by PoE supporting powering supply for door lock)
	Working temperature	-30 °C to 60 °C (-22 °F to 140 °F)
	Working humidity	0 to 90% (No condensing)
	Dimensions	91.3 mm × 181.3 mm × 24.5 mm (3.59" × 7.14" × 0.96")
	Installation	Wall Mounting
	Protective level	IP65
	Weight	Gross weight: 0.93 kg (2.05 lbs) Net weight: 0.36 kg (0.79 lbs)
	Language	English, Spanish (South America), Arabic, Thai, Indonesian, Russian, Vietnamese, Brazilian Portuguese, Japanese, Korean, Chinese Traditional, French, Turkish, Kazakh and Uzbek.
	Platform	Hik-ProConnect and HikCentral Professional



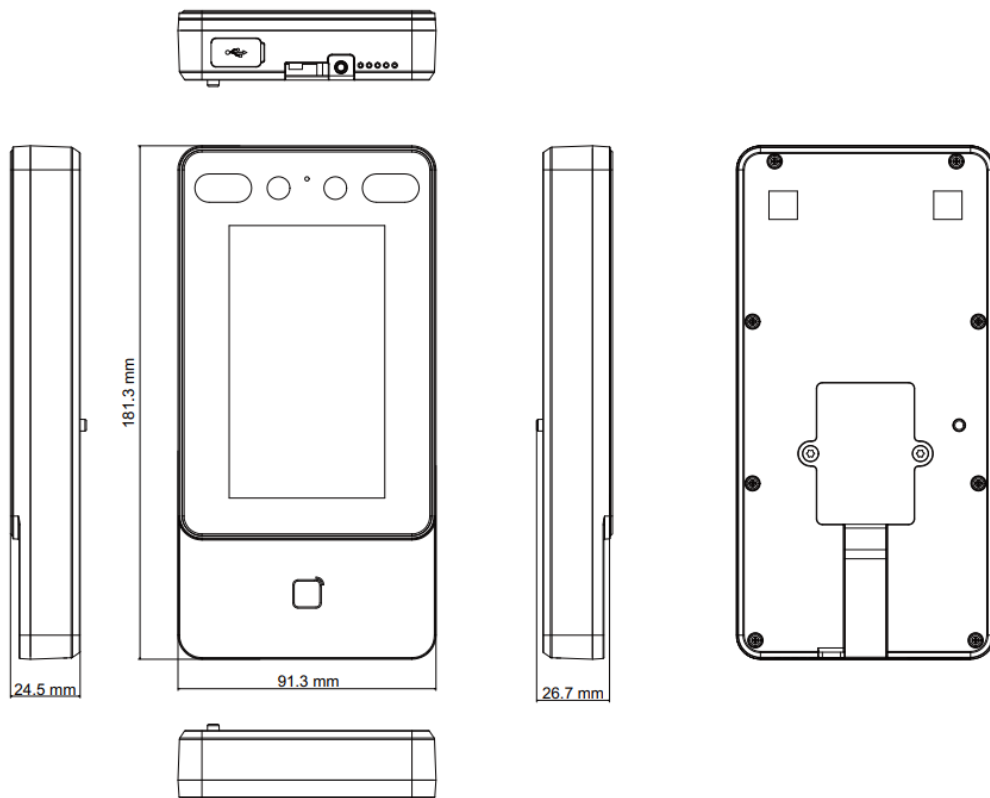

Function	QR code recognition	Support QR code 2.0
	Multiple faces detection	Not support
	Face anti-spoofing	Support
	Live view	Support
	Two-way audio	Support
	Advertisement	Not support
	Audio prompt	Support
	M1 card encryption	Support
	Anti-passback	Not support
	First person in	Support
	Multi-factor authentication	Support
	Time synchronization	Support

▪ **Dimension**



▪ **Accessory**

▪ **Optional**

DS-KAB6-ZU3 Brackets for face terminals	DS-KAB6-W1 Bracket	DS-KAB6-ZU1 Brackets for face terminals	DS-KAB34X-S1 Protective Shield	DS-KAB671-P2 Stand Stick
				

See Far, Go Further



www.hikvision.com
support@hikvision.com

