

**DS-2CD3121G2E-LIU(/AB)  
2 MP Dual Light Motion 2.0 Fixed Dome Network Camera**

Hikvision has been dedicated to develop products with security since established. Hikvision always follows security by design principle and has adopted many methods of security technologies into our product development lifecycle, including terminal security, data security, application security, network security, and privacy protection.

In the meantime, the security technologies used by Hikvision are all in compliance with local applicable laws and safety regulations. These security measures could enhance product's cyber security defense capability and protect your devices as well as your data from malicious cyber attacks.

- High quality imaging with 2 MP resolution
- Support Human and Vehicle Detection
- Efficient H.265+ compression technology
- Smart Hybrid Light: advanced technology with long range
- Clear imaging against strong back light due to Digital WDR technology
- 3D DNR technology delivers clean and sharp images
- Built-in microphone for real-time audio security
- Easy installation with Power over Ethernet (PoE) technology
- Water and dust resistant (IP67) and vandal resistant (IK08)

## ▪ Specification

Camera	
Image Sensor	1/2.9" Progressive Scan CMOS
Max. Resolution	1920 × 1080
Shutter Time	1/3 s to 1/100,000 s
Min. Illumination	Color: 0.01 Lux @ (F2.0, AGC ON), 0 Lux with light
Day & Night	IR cut filter
Angle Adjustment	Pan: 0° to 355°, tilt: 0° to 75°, rotate: 0° to 355°
Lens	
Lens Type	Fixed focal lens, 2.8 and 4 mm optional
Focal Length & FOV	2.8 mm, horizontal FOV 99.5°, vertical FOV 55.5°, diagonal FOV 116.1° 4 mm, horizontal FOV 76.8°, vertical FOV 41.5°, diagonal FOV 90.8°
Lens Mount	M12
Iris Type	Fixed
Aperture	F2.0
DORI	
DORI	2.8 mm, D: 59 m, O: 23 m, R: 11 m, I: 5 m 4 mm, D: 79 m, O: 31 m, R: 15 m, I: 7 m
Illuminator	
Supplement Light Type	IR, White Light
Supplement Light Range	Up to 30 m
Smart Supplement Light	Yes
IR Wavelength	850 nm
Video	
Main Stream	50 Hz: 25 fps (1920 × 1080, 1280 × 720) 60 Hz: 30 fps (1920 × 1080, 1280 × 720)
Sub-Stream	50 Hz: 25 fps (1280 × 720, 640 × 480, 640 × 360) 60 Hz: 30 fps (1280 × 720, 640 × 480, 640 × 360)
Video Compression	Main stream: H.265+/H.265/H.264+/H.264, Sub-stream: H.265/H.264/MJPEG
Video Bit Rate	32 Kbps to 8 Mbps
H.264 Type	Baseline Profile, Main Profile, High Profile
H.265 Type	Main Profile
Bit Rate Control	CBR, VBR
Region of Interest (ROI)	1 fixed region for main stream and sub-stream
Audio	
Audio Type	Mono sound
Environment Noise Filtering	Yes
Audio Sampling Rate	8 kHz/16 kHz
Audio Compression	G.711/G.722.1/G.726/MP2L2/PCM/MP3/AAC-LC
Audio Bit Rate	64 Kbps (G.711ulaw/G.711alaw)/16 Kbps (G.722.1)/16 Kbps (G.726)/32 to 192 Kbps (MP2L2)/8 to 320 Kbps (MP3)/16 to 64 Kbps (AAC-LC)

<b>Network</b>	
Security	Password protection, complicated password, HTTPS encryption, 802.1X authentication (EAP-MD5), watermark, basic and digest authentication for HTTP/HTTPS, WSSE and digest authentication for Open Network Video Interface, RTP/RTSP over HTTPS, security audit log, TLS 1.2, TLS 1.3, host authentication (MAC address)
Simultaneous Live View	Up to 6 channels
API	Open Network Video Interface (Profile S, Profile G), ISAPI, SDK
Protocols	TCP/IP, ICMP, DHCP, DNS, HTTP, RTP, RTSP, NTP, IGMP, IPv6, UDP, QoS, FTP, SMTP, HTTPS, DDNS, UPnP, 802.1X
User/Host	Up to 32 users 3 user levels: administrator, operator, and user
Client	iVMS-4200, Hik-Connect
Web Browser	Plug-in required live view: IE 10, IE 11, Local service: Chrome 57.0+, Firefox 52.0+, Edge 89+
<b>Image</b>	
Wide Dynamic Range (WDR)	Digital WDR
SNR	≥ 52 dB
Day/Night Switch	Day, Night, Auto, Schedule
Image Enhancement	BLC, HLC, 3D DNR
Image Settings	Rotate mode, saturation, brightness, contrast, sharpness, gain, white balance, adjustable by client software or web browser
Privacy Mask	4 programmable polygon privacy masks
<b>Interface</b>	
Ethernet Interface	1 RJ45 10 M/100 M self-adaptive Ethernet port
Built-in Microphone	Yes
<b>Event</b>	
Basic Event	Motion detection (support alarm triggering by specified target types (human and vehicle)), video tampering alarm, exception
Smart Event	Line crossing detection, intrusion detection
Linkage	Upload to FTP, send email, notify surveillance center, trigger capture
<b>General</b>	
Power	12 VDC ± 25%, 0.5 A, max. 6 W, Ø5.5 mm coaxial power plug, reverse polarity protection, PoE: IEEE 802.3af, Class 3, max. 7.5 W
Material	Base: aluminum alloy, cover: plastic
Dimension	Ø121.5 mm × 97.6 mm (Ø4.78" × 3.84")
Package Dimension	150 mm × 150 mm × 141 mm (5.9" × 5.9" × 5.6")
Weight	Approx. 490 g (1.1 lb.)
With Package Weight	Approx. 680 g (1.5 lb.)
Storage Conditions	-30 °C to 60 °C (-22 °F to 140 °F). Humidity 95% or less (non-condensing)
Startup and Operating Conditions	-30 °C to 60 °C (-22 °F to 140 °F). Humidity 95% or less (non-condensing)
Language	English, Turkish, Polish, Romanian, Czech, Slovak, Traditional Chinese, Thai, Vietnamese, Croatian, Slovenian, Serbian, Ukrainian

General Function	Heartbeat,mirror,password reset via email,pixel counter,password protection,anti-banding
<b>Approval</b>	
EMC	CE-EMC: EN 55032:2015+A1:2020, EN 50130-4:2011+A1:2014, EN IEC 61000-3-2:2019+A1:2021, EN 61000-3-3:2013+A1:2019+A2:2021, IC: ICES-003: Issue 7
Safety	UL: UL 62368-1, CB: IEC 62368-1:2014+A11, CE-LVD: EN 62368-1:2014/A11: 2017, BIS: IS 13252 (Part1): 2010/IEC 60950-1:2005
Environment	CE-RoHS: 2011/65/EU
Protection	IP67:IEC 60529-2013,IK08:IEC 62262:2002

## ▪ Typical Application

Hikvision products are classified into three levels according to their anti-corrosion performance. Refer to the following description to choose for your using environment.

This model has NO SPECIFIC PROTECTION.

Level	Description
Top-level protection	Hikvision products at this level are equipped for use in areas where professional anti-corrosion protection is a must. Typical application scenarios include coastlines, docks, chemical plants, and more.
Moderate protection	Hikvision products at this level are equipped for use in areas with moderate anti-corrosion demands. Typical application scenarios include coastal areas about 2 kilometers (1.24 miles) away from coastlines, as well as areas affected by acid rain.
No specific protection	Hikvision products at this level are equipped for use in areas where no specific anti-corrosion protection is needed.

## ▪ Dimension

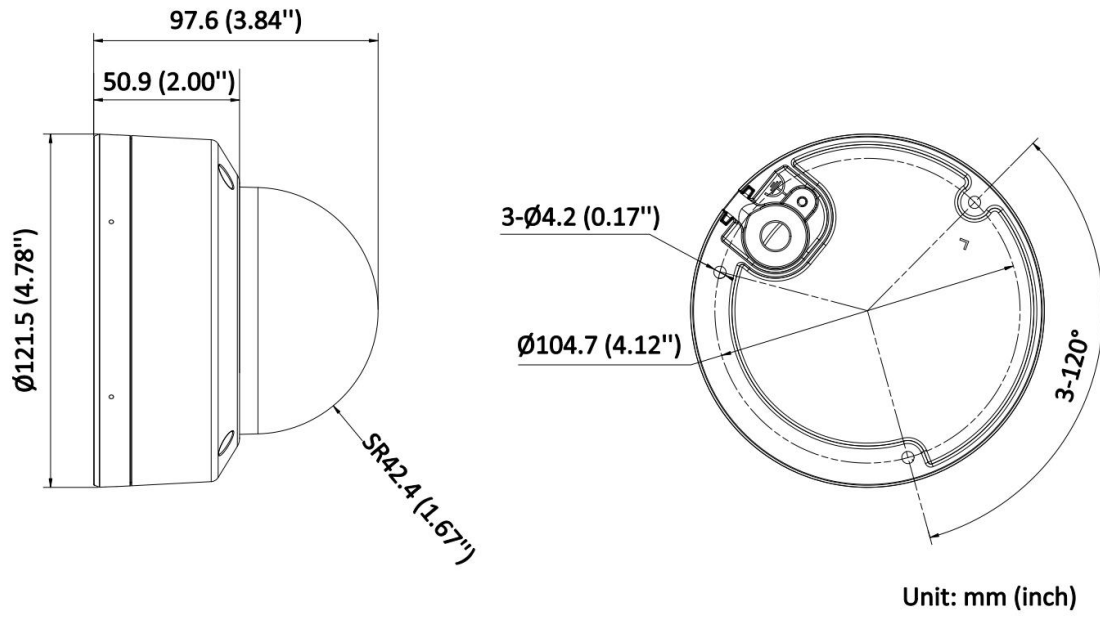





▪ **Accessory**

▪ **Optional**

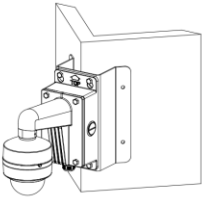
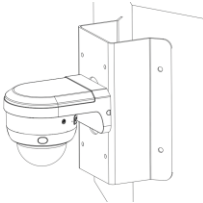
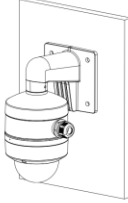
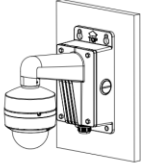
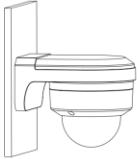
<b>DS-1276ZJ-SUS</b>	<b>DS-1272ZJ-120</b>	<b>DS-1272ZJ-120B</b>	<b>DS-1275ZJ-SUS</b>	<b>DS-1275ZJ-S-SUS</b>
<b>DS-1476ZJ-SUS</b>	<b>DS-1271ZJ-120</b>	<b>DS-220AZJ-130-WA</b>	<b>DS-1475ZJ-SUS</b>	<b>DS-220AZJ-145-WA</b>
<b>DS-1280ZJ-DM46</b>	<b>DS-4221ZJ-WC</b>			

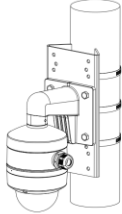
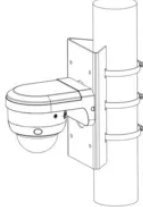
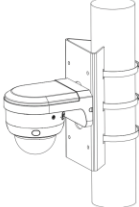
▪ **Installation Methods**

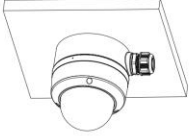
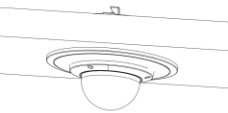
<p><b>Corner Mounting</b> DS-1276ZJ-SUS+DS-1272ZJ-120B</p>	<p><b>Corner Mounting</b> DS-1476ZJ-SUS+DS-220AZJ-130-WA</p>	<p><b>Wall Mounting</b> DS-1272ZJ-120+DS-1280ZJ-DM46</p>	<p><b>Wall Mounting</b> DS-1272ZJ-120B</p>	<p><b>Wall Mounting</b> DS-220AZJ-130-WA</p>
				
<p><b>Wall Mounting</b> DS-220AZJ-145-WA</p>	<p><b>Vertical Pole Mounting</b> DS-1275ZJ-SUS+DS-1272ZJ-120+DS-1280ZJ-DM46</p>	<p><b>Vertical Pole Mounting</b> DS-1275ZJ-S-SUS+DS-220AZJ-145-WA</p>	<p><b>Vertical Pole Mounting</b> DS-1475ZJ-SUS+DS-220AZJ-130-WA</p>	<p><b>Pendant Mounting</b> DS-1271ZJ-120</p>
				
<p><b>Junction Box</b> DS-1280ZJ-DM46</p>	<p><b>In-Ceiling Mounting</b> DS-4221ZJ-WC</p>			
				

# See Far, Go Further



[www.hikvision.com](http://www.hikvision.com)  
[support@hikvision.com](mailto:support@hikvision.com)

