

DS-2CD3141G2-ISF
4MP Fixed Dome Network Camera

Hikvision has been dedicated to develop products with security since established. Hikvision always follows security by design principle and has adopted many methods of security technologies into our product development lifecycle, including terminal security, data security, application security, network security, and privacy protection. In the meantime, the security technologies used by Hikvision are all in compliance with local applicable laws and safety regulations. These security measures could enhance product's cyber security protection capability and protect your devices as well as your data from malicious cyber attacks.

- High quality imaging with 4 MP resolution
- Efficient H.265+ compression technology to save bandwidth and storage
- Clear imaging against strong back light due to 120dB WDR technology
- 3D DNR technology delivers clean and sharp images
- Easy installation with Power over Ethernet (PoE) technology
- Water and dust resistant (IP67) and vandal proof (IK08)
- Support Human and Vehicle Detection

▪ Specification

Camera	
Image Sensor	1/2.9" Progressive Scan CMOS
Max. Resolution	2560 × 1440
Shutter Time	1/3 s to 1/100,000 s
Min. Illumination	Color: 0.005 Lux @ (F1.6, AGC ON), B/W: 0 Lux with IR
Day & Night	IR cut filter
Angle Adjustment	Pan: 0° to 355°, tilt: 0° to 75°, rotate: 0° to 355°
Lens	
Lens Type	Fixed focal lens, 2.8 and 4 mm optional
Focal Length & FOV	2.8 mm, horizontal FOV 98.2°, vertical FOV 54.2°, diagonal FOV 114.6° 4 mm, horizontal FOV 78.8°, vertical FOV 42.3°, diagonal FOV 93.4°
Lens Mount	M12
Iris Type	Fixed
Aperture	F1.6
DORI	
DORI	2.8 mm, D: 63 m, O: 25 m, R: 12 m, I: 6 m 4 mm, D: 78 m, O: 31 m, R: 15 m, I: 7 m
Illuminator	
Supplement Light Type	IR
Supplement Light Range	Up to 40 m
Smart Supplement Light	Yes
IR Wavelength	850 nm
Video	
Main Stream	50 Hz: 25 fps (2560 × 1440, 1920 × 1080, 1280 × 720) 60 Hz: 24 fps (2560 × 1440, 1920 × 1080, 1280 × 720)
Sub-Stream	50 Hz: 25 fps (1280 × 720, 640 × 480, 640 × 360) 60 Hz: 24 fps (1280 × 720, 640 × 480, 640 × 360)
Third Stream	50 Hz: 1 fps (640 × 360) 60 Hz: 1 fps (640 × 360)
Video Compression	Main stream: H.265+/H.265/H.264+/H.264, Sub-stream: H.265/H.264/MJPEG, Third stream: H.265/H.264
Video Bit Rate	32 Kbps to 8 Mbps
H.264 Type	Baseline Profile, Main Profile, High Profile
H.265 Type	Main Profile
Bit Rate Control	CBR, VBR
Region of Interest (ROI)	1 fixed region for main stream and sub-stream
Audio	
Audio Type	Mono sound
Environment Noise Filtering	Yes
Audio Sampling Rate	8 kHz/16 kHz
Audio Compression	G.711ulaw/G.711alaw/G.722.1/G.726/MP2L2/PCM/AAC-LC
Audio Bit Rate	64 Kbps (G.711 ulaw)/64 Kbps (G.711 alaw)/16 Kbps (G.722.1)/16 Kbps (G.726)/32 to 160 Kbps (MP2L2)/16 to 64 Kbps (AAC-LC)

Network	
Security	Password protection, complicated password, HTTPS encryption, 802.1X authentication (EAP-MD5), watermark, basic and digest authentication for HTTP/HTTPS, WSSE and digest authentication for Open Network Video Interface, RTP/RTSP over HTTPS, security audit log, TLS 1.2, TLS 1.3, host authentication (MAC address)
Simultaneous Live View	Up to 6 channels
API	Open Network Video Interface (Profile S, Profile T, Profile G), ISAPI, SDK
Protocols	TCP/IP, ICMP, DHCP, DNS, HTTP, RTP, RTSP, RTCP, NTP, IGMP, IPv4, IPv6, UDP, QoS, FTP, SMTP, HTTPS, DDNS, UPnP, 802.1X
User/Host	Up to 32 users 3 user levels: administrator, operator, and user
Client	iVMS-4200, Hik-Connect
Web Browser	Plug-in required live view: IE 10, IE 11, Local service: Chrome 57.0+, Firefox 52.0+, Edge 89+
Image	
Wide Dynamic Range (WDR)	120 dB
SNR	≥ 52 dB
Day/Night Switch	Day, Night, Auto, Schedule
Image Enhancement	BLC, HLC, 3D DNR
Image Settings	Rotate mode, saturation, brightness, contrast, sharpness, gain, white balance, adjustable by client software or web browser
Privacy Mask	4 programmable polygon privacy masks
Interface	
Ethernet Interface	1 RJ45 10 M/100 M self-adaptive Ethernet port
On-Board Storage	Built-in memory card slot, support microSD/microSDHC/microSDXC card, up to 512 GB
Audio	1 input (line in), two-core terminal block, max. input amplitude: 3.3 Vpp, input impedance: 4.7 KΩ, interface type: non-equilibrium, 1 output (line out), two-core terminal block, max. output amplitude: 3.3 Vpp, output impedance: 100 Ω, interface type: non-equilibrium
Alarm	1 input, 1 output (max. 12 VDC, 30 mA)
Reset Key	Yes
Event	
Basic Event	Motion detection (support alarm triggering by specified target types (human and vehicle)), video tampering alarm, exception
Smart Event	Line crossing detection, intrusion detection
Linkage	Upload to FTP/memory card, send email, notify surveillance center, trigger recording, trigger capture, trigger alarm output, audible warning
General	
Power	12 VDC ± 25%, 0.4 A, max. 5 W, Ø5.5 mm coaxial power plug, reverse polarity protection, PoE: IEEE 802.3af, Class 3, max. 6.5 W
Material	Base: Metal, cover: Plastic
Dimension	Ø110,8 mm × 84.7 mm (Ø4.4" × 3.3")

Package Dimension	134 mm × 134 mm × 108 mm (5.3" × 5.3" × 4.3")
Weight	Approx. 497 g (1.1 lb.)
With Package Weight	Approx. 597 g (1.3 lb.)
Storage Conditions	-30 °C to 60 °C (-22 °F to 140 °F). Humidity 95% or less (non-condensing)
Startup and Operating Conditions	-30 °C to 60 °C (-22 °F to 140 °F). Humidity 95% or less (non-condensing)
Language	English, Turkish, Polish, Romanian, Czech, Slovak, Traditional Chinese, Thai, Vietnamese, Croatian, Slovenian, Serbian, Ukrainian
General Function	Heartbeat, anti-banding, mirror, password protection, password reset via email, pixel counter
Approval	
EMC	FCC: 47 CFR Part 15, Subpart B
Safety	CB: IEC 62368-1:2014+A11, CE-LVD: EN 62368-1:2014/A11: 2017, BIS: IS 13252 (Part 1): 2010/IEC 60950-1:2005
Environment	CE-RoHS: 2011/65/EU
Protection	IP67: IEC 60529-2013, IK08: IEC 62262:2002

▪ Typical Application

Hikvision products are classified into three levels according to their anti-corrosion performance. Refer to the following description to choose for your using environment.

This model has NO SPECIFIC PROTECTION.

Level	Description
Top-level protection	Hikvision products at this level are equipped for use in areas where professional anti-corrosion protection is a must. Typical application scenarios include coastlines, docks, chemical plants, and more.
Moderate protection	Hikvision products at this level are equipped for use in areas with moderate anti-corrosion demands. Typical application scenarios include coastal areas about 2 kilometers (1.24 miles) away from coastlines, as well as areas affected by acid rain.
No specific protection	Hikvision products at this level are equipped for use in areas where no specific anti-corrosion protection is needed.

▪ Dimension

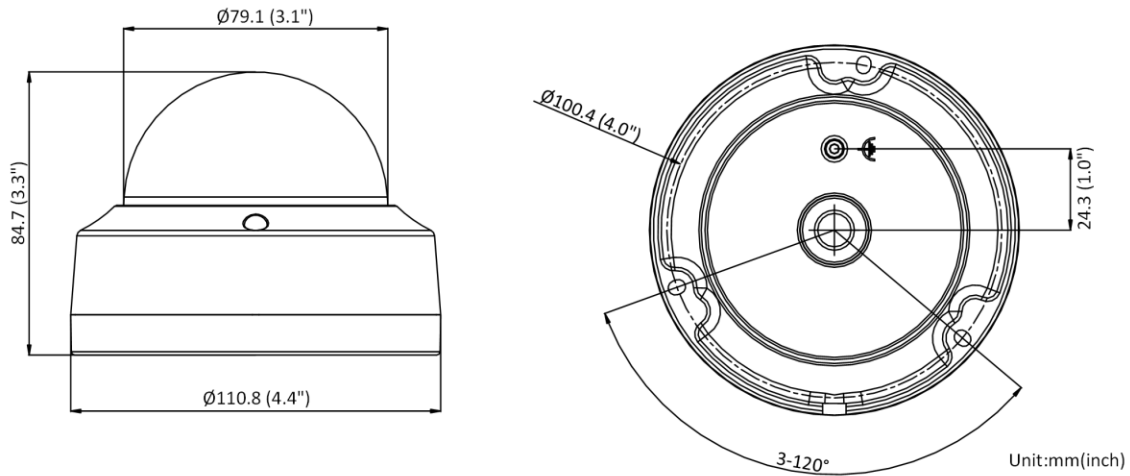









▪ **Accessory**

▪ **Optional**

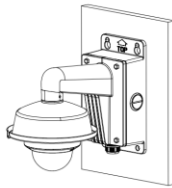
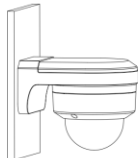
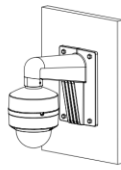
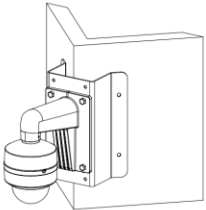
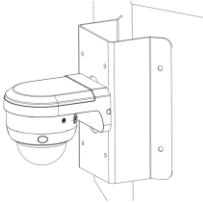
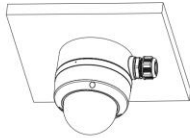
DS-220AZJ-145-WA	DS-1276ZJ-SUS	DS-1280ZJ-DM18	DS-1272ZJ-110	DS-1275ZJ-S-SUS
DS-1250ZJ	DS-1476ZJ-SUS	DS-1275ZJ-SUS	DS-1475ZJ-SUS	DS-1271ZJ-110
DS-1272ZJ-110B	DS-220AZJ-130-WA	DS-1258ZJ	DS-1259ZJ	

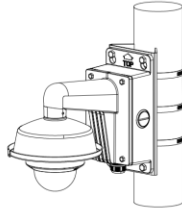
▪ **Installation Methods**

Wall Mounting DS-220AZJ-145-WA	Wall Mounting DS-1272ZJ-110+DS-12 53ZJ-M	Wall Mounting DS-1272ZJ-110B+DS-1 253ZJ-M	Wall Mounting DS-220AZJ-130-WA	Wall Mounting DS-1258ZJ
---	---	--	---	--

				
<p>Corner Mounting DS-1276ZJ-SUS+DS-1272ZJ-110</p>	<p>Corner Mounting DS-1476ZJ-SUS+DS-220AZJ-145-WA</p>	<p>Junction Box DS-1280ZJ-DM18</p>	<p>Vertical Pole Mounting DS-1275ZJ-S-SUS+DS-220AZJ-145-WA</p>	<p>Vertical Pole Mounting DS-1275ZJ-SUS+DS-1272ZJ-110B+DS-1253ZJ-M</p>
				
<p>Vertical Pole Mounting DS-1475ZJ-SUS+DS-220AZJ-145-WA</p>	<p>Others DS-1250ZJ</p>	<p>Pendant Mounting DS-1271ZJ-110</p>	<p>Inclined Ceiling Mounting DS-1259ZJ</p>	
				

See Far, Go Further



www.hikvision.com
support@hikvision.com

