

DS-2DF8C435MHS-DELW(B) 8C Series 4 MP 35X DarkFighterX IR Network Speed Dome



Hikvision DS-2DF8C435MHS-DELW(T5) 4MP 35 × Network IR Speed Dome adopts 1/1.8" progressive scan CMOS chip. With the 35 × optical zoom lens, the camera offers more details over expansive areas. This series of cameras can be widely used for wide ranges of high-definition, such as the rivers, forests, roads, railways, airports, ports, squares, parks, scenic spots, stations and large venues, etc. Hikvision has been dedicated to develop products with security since established. Hikvision always follows security by design principle and has adopted many methods of security technologies into our product development lifecycle, including terminal security, data security, application security, network security, and privacy protection. In the meantime, the security technologies used by Hikvision are all in compliance with local applicable laws and safety regulations. These security measures could enhance product's cyber security defense capability and protect your devices as well as your data from malicious cyber attacks.

- Dual sensor 1/1.8" progressive scan CMOS
- High quality imaging with 4 MP resolution
- Excellent low-light performance with DarkFighterX technology
- 35× optical zoom and 16× digital zoom provide close up views over expansive areas
- 300 m IR distance
- Water and dust resistant (IP67) and vandal resistant (IK10)
- Supports face capture to detect, capture, grade, and select faces in motion
- Supports road traffic to detect vehicles
- Efficient H.265+/H.265 compression technology
- 140 dB WDR, 3D DNR, HLC, BLC, EIS, defog

▪ Specification

Camera	
Image Sensor	Two sensors, 1/1.8" Progressive Scan CMOS
Max. Resolution	2560 × 1440
Min. Illumination	Color: 0.0004 Lux @ (F1.6, AGC ON), B/W: 0.0001 Lux @ (F1.6, AGC ON), 0 Lux with IR
Shutter Speed	1/1 s to 1/30000 s
Zoom	35 × optical, 16 × digital
Slow Shutter	Yes
BLC	yes
3D DNR	yes
Lens	
Focal Length	5.9 to 206.5 mm
FOV	Horizontal field of view: 60.2° to 2.24°, vertical field of view: 36° to 1.26°, diagonal field of view: 68° to 2.56°
Focus	Auto, semi-auto, manual
Aperture	Max. F1.6
Zoom Speed	Approx. 4.3 s
Illuminator	
Supplement Light Type	Hybrid
Supplement Light Range	IR distance: up to 300 m
Smart Supplement Light	Yes
PTZ	
Movement Range (Pan)	360° endless
Movement Range (Tilt)	-20° to 90°, auto flip
Pan Speed	Pan speed: configurable from 0.1° to 210°/s, preset speed: 280°/s
Tilt Speed	Tilt speed: configurable from 0.1° to 150°/s, preset speed 250°/s
Proportional Pan	Yes
Presets	300
Preset Freezing	Yes
Patrol Scan	8 patrols, up to 32 presets for each patrol
Pattern Scan	4 pattern scans, record time over 10 minutes for each scan
Park Action	Preset, pattern scan, patrol scan, auto scan, tilt scan, random scan, frame scan, panorama scan
3D Positioning	Yes
PTZ Status Display	Yes
Scheduled Task	Preset, pattern scan, patrol scan, auto scan, tilt scan, random scan, frame scan, dome reboot, dome adjust, aux output, panorama scan
Power-off Memory	Yes
Video	
Main Stream	50 Hz: 25 fps (2560 × 1440, 1920 × 1080, 1280 × 960, 1280 × 720) 60 Hz: 30 fps (2560 × 1440, 1920 × 1080, 1280 × 960, 1280 × 720)
Sub-Stream	50 Hz: 25 fps (704 × 576, 640 × 480, 352 × 288) 60 Hz: 30 fps (704 × 480, 640 × 480, 352 × 240)
Third Stream	50 Hz: 25 fps (1920 × 1080, 1280 × 960, 1280 × 720, 704 × 576, 640 × 480, 352 × 288) 60 Hz: 30 fps (1920 × 1080, 1280 × 960, 1280 × 720, 704 × 480, 640 × 480, 352 × 240)

Video Compression	Main stream: H.265+/H.265/H.264+/H.264, Sub-stream: H.265/H.264/MJPEG, Third stream: H.265/H.264/MJPEG
Video Bit Rate	32 Kbps to 16 Mbps
H.264 Type	Baseline profile,Main profile,High profile
H.265 Type	Main profile
Scalable Video Coding (SVC)	H.264 and H.265 encoding
Region of Interest (ROI)	8 fixed regions for each stream
Audio	
Audio Compression	G.711,G.722.1,G.726,MP2L2,PCM,AAC-LC
Audio Bit Rate	64 Kbps (G.711),16 Kbps (G.722.1),16 Kbps (G.726),32 to 192 Kbps (MP2L2),16 to 64Kbps (AAC-LC)
Network	
Protocols	TCP/IP,ICMP,HTTP,HTTPS,FTP,DHCP,DNS,DDNS,RTP,RTSP,RTCP,PPPoE,NTP,UPnP,SMTP ,SNMP,IGMP,802.1X,QoS,IPv4/IPv6,UDP,Bonjour
Simultaneous Live View	Up to 20 channels
API	Open Network Video Interface (Profile S, Profile G, Profile T),ISAPI,SDK,ISUP
User/Host	Up to 32 users. 3 user levels: administrator, operator, and user
Security	Password protection,complicated password,HTTPS encryption,802.1X authentication (EAP-TLS, EAP-LEAP, EAP-MD5),watermark,IP address filter,basic and digest authentication for HTTP/HTTPS,WSSE and digest authentication for Open Network Video Interface, RTP/RTSP over HTTPS,control timeout settings,security audit log,TLS 1.3,host authentication (MAC address)
Network Storage	NAS (NFS, SMB/CIFS),auto network replenishment (ANR)
Client	iVMS-4200,HikCentral Pro,Hik-Connect
Web Browser	Safari 12+,Chrome57+,Firefox52+,IE10+
Image	
Image Parameters Switch	Yes
Image Settings	Saturation, brightness, contrast, sharpness, gain, and white balance adjustable by client software or web browser
Day/Night Switch	Day,night,auto,schedule
Wide Dynamic Range (WDR)	140 dB
SNR	≥ 52 dB
Defog	Optical defog
Image Stabilization	EIS (Built-in gyroscope to improve EIS performance)
Privacy Mask	24 programmable polygon privacy masks, mask color or mosaic configurable
Regional Focus	Yes
Regional Exposure	Yes
Supplement Detection	
Satellite Positioning	No
Gyroscope	Yes
Compass	No
Interface	
Video Output	CVBS: 1.0 V[p-p]/75 Ω, PAL/NTSC, BNC connector
Ethernet Interface	1 RJ45 10M/100M self-adaptive Ethernet port
On-board Storage	Built-in memory card slot, support microSD/microSDHC/microSDXC card, up to 256 GB

Audio	1 input (line in), max. input amplitude: 2-2.4 vpp, input impedance: 1 K Ω \pm 10%, 1 output (line out), line level, output impedance: 600 Ω
Alarm	7 input(s), 2 output(s)
RS-485	1 RS-485 (Half duplex, HIKVISION, Pelco-P, Pelco-D, self-adaptive)
Reset	Yes
Event	
Basic Event	Motion detection, video tampering alarm, exception, alarm input and output
Smart Event	Line crossing detection, intrusion detection, region entrance detection, region exiting detection, audio exception detection, unattended baggage detection, object removal detection
Linkage	Upload to FTP/NAS/memory card, notify surveillance center, send email, trigger alarm output, trigger recording, trigger capture, and PTZ actions (such as preset, patrol scan, pattern scan)
Smart Tracking	Manual tracking, auto-tracking
Deep Learning Function	
Face Capture	Supports detecting, tracking, capturing, grading, selecting of face in motion, and outputs the best face picture
Face Comparison	Recognizes face identity via face modeling, grading and comparing to those in face library
Road Traffic and Vehicle Detection	
Road Traffic	Support vehicle detection (license plate number, vehicle model, and vehicle color recognition)
General	
Power	36 VDC \pm 25%, max. 62 W, Hi-PoE
Dimension	\varnothing 267.4 mm \times 431.1 mm (\varnothing 10.53" \times 16.97")
Weight	Approx. 10 kg (22.05 lb.)
Material	ADC12
Operating Condition	-40 $^{\circ}$ C to 70 $^{\circ}$ C (-40 $^{\circ}$ F to 158 $^{\circ}$ F). Humidity 95% or less (non-condensing)
Vandal-proof Alarm	Yes
Heater	Yes
Wiper	Yes
Demist	Yes
Language	33 languages: English, Russian, Estonian, Bulgarian, Hungarian, Greek, German, Italian, Czech, Slovak, French, Polish, Dutch, Portuguese, Spanish, Romanian, Danish, Swedish, Norwegian, Finnish, Croatian, Slovenian, Serbian, Turkish, Korean, Traditional Chinese, Thai, Vietnamese, Japanese, Latvian, Lithuanian, Portuguese (Brazil), Ukrainian
Approval	
EMC	FCC (47 CFR Part 15, Subpart B), CE-EMC (EN 55032:2015, EN 61000-3-2:2019, EN 61000-3-3:2013 + A1: 2019, EN 50130-4:2011 + A1: 2014), KC (KN 32: 2015, KN 35: 2015), RCM (AS/NZS CISPR 32: 2015), IC (ICES-003: Issue 7)
Safety	UL (UL 62368-1), CB (IEC 62368-1:2014 + A11), CE-LVD (EN 62368-1:2014/A11: 2017), BIS (IS 13252 (Part 1): 2010/IEC 60950-1:2005), LOA (IEC/EN 60950-1)
Environment	CE-RoHS (2011/65/EU), WEEE (2012/19/EU), Reach (Regulation (EC) No 1907/2006)

Protection	IP67 (IEC 60529-2013),IK10 (IEC 62262:2002),TVS 6K V lightning protection, surge protection and voltage transient protection
------------	--

▪ DORI

The DORI (detect, observe, recognize, identify) distance gives the general idea of the camera ability to distinguish persons or objects within its field of view.

It is calculated based on the camera sensor specification and the criteria given by EN 62676-4:2015.

DORI	Detect	Observe	Recognize	Identify
Definition	25 px/m	63 px/m	125 px/m	250 px/m
Distance (Tele)	2848.3 m	1130.3 m	569.7 m	284.8 m

▪ Typical Application

Level	Description
Top-level protection	Hikvision products at this level are equipped for use in areas where professional anti-corrosion protection is a must. Typical application scenarios include coastlines, docks, chemical plants, and more.
Moderate protection	Hikvision products at this level are equipped for use in areas with moderate anti-corrosion demands. Typical application scenarios include coastal areas about 2 kilometers (1.24 miles) away from coastlines, as well as areas affected by acid rain.
No specific protection	Hikvision products at this level are equipped for use in areas where no specific anti-corrosion protection is needed.

Hikvision products are classified into three levels according to their anti-corrosion performance. Refer to the following description to choose for your using environment.

This model has NO SPECIFIC PROTECTION.

▪ Available Model



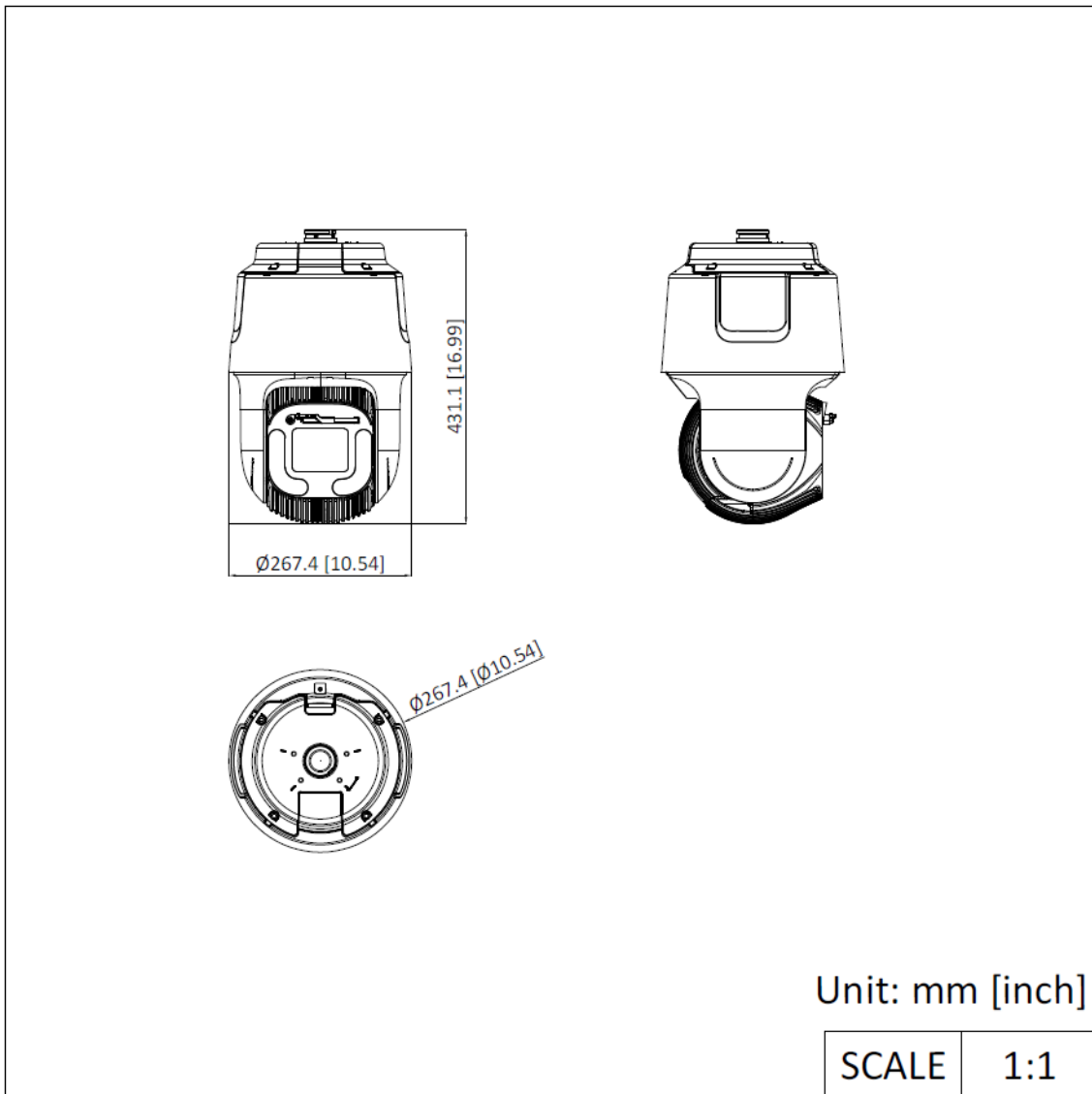

DS-2DF8C435MHS-DELW(B)

▪ Dimension



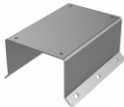





▪ Accessory

▪ Optional

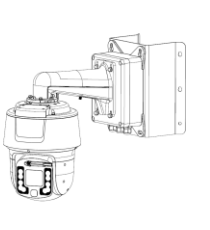
DS-1673ZJ-P	DS-4660ZJ-PC	DS-4650ZJ-PC	DS-1276ZJ-P	DS-4612ZJ-PA
				
DS-1674ZJ-P	DS-1684ZJ-P	DS-4603ZJ-PA		

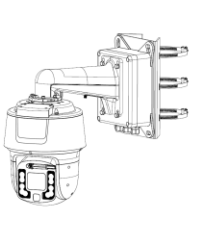
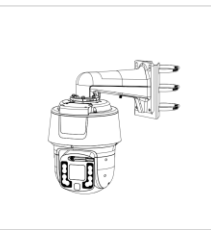

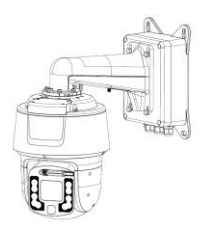
▪ **Installation Methods**

<p>Horizontal Pole Mounting DS-1673ZJ-P+DS-4612 ZJ-PA</p>	<p>Corner Mounting DS-4660ZJ-PC+DS-1674ZJ-P+DS-4603ZJ-PA</p>	<p>Corner Mounting DS-1276ZJ-P+DS-4603 ZJ-PA</p>	<p>Vertical Pole Mounting DS-4650ZJ-PC+DS-1674ZJ-P+DS-4603ZJ-PA</p>	<p>Vertical Pole Mounting DS-1684ZJ-P+DS-4603 ZJ-PA</p>
				
<p>Pendant Mounting DS-4612ZJ-PA</p>	<p>Junction Box DS-1674ZJ-P+DS-4603 ZJ-PA</p>		<p>Wall Mounting DS-4603ZJ-PA</p>	
				

See Far, Go Further



www.hikvision.com
support@hikvision.com

