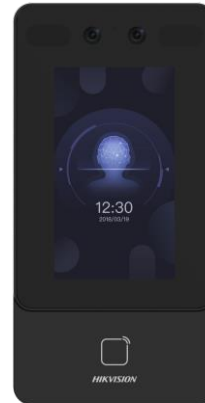

**DS-K1T342EWX****Value Series Face Access Terminal**

Face recognition terminal adopts deep learning algorithm, which helps to recognize the face faster with higher accuracy. It also supports multiple authentication modes: face/card authentication, etc. It can be applied in multiple scenarios, such as buildings, enterprises, financial industries, and other important areas.

- Max.1500 faces capacity, and Max.3000 cards
- Face Recognition Terminal, 4.3-inch LCD touch screen, 2 Mega pixel wide-angle lens, Built-in EM card reading module
- Two-way audio with client software, indoor station, and main station; Supports TCP/IP、Wi-Fi
- Supports ISAPI, ISUP5.0
- Configuration via the web client
- Face Recognition Distance: 0.3 m to 1.5 m
- Duration < 0.2 s/User
- Accuracy rate  $\geq$  99%
- Supports mask recognition
- Supports Push SDK.
- Supports face duplicate check, preventing multiple people from using the same face.
- Supports the following SIP servers: ASTERISK, 3CX, ELASTIX, miniSipServer, Brekeke, OpenSIPs, Kamailio.
- Supports attendance-only function.

## ▪ Specification

Model		DS-K1T342EWX
System	Operating system	Linux
	ROM	4 GB
	RAM	DDR3:512 M
	CPU	900 MHz
Display	Screen size	4.3 inch
	Operation method	Capacitive touch screen
	Type	LCD
	Resolution	272 × 480
Video	Lens	2
	Resolution	2 MP
	Wide Dynamic Range (WDR)	Support
	Video standard	PAL (Default) and NTSC
	Focal length	4 mm
	Aperture	F 2.0
	HOV	HFOV: 75.5°;                      VFOV: 41.5°;                      DFOV: 87°
Audio	Audio compression standard	G.711U
	Audio compression bitrate	64 Kbps
	Audio input	Built-in omnidirectional microphone
	Audio output	Built-in loudspeaker
	Audio quality	Noise suppression and echo cancellation
	Volume adjustment	Adjust via device or client
	Power output	1 W
Network	Network protocol	ISAPI, ISUP5.0
	Wired network	Support
	Wi-Fi	Support, 2.4 G, 802.11b/g/n
Interface	Network interface	1 RJ-45, 10/100 M self-adaptive
	Lock control	1
	Exit button	1
	Door contact input	1
	TAMPER	1

	RS-485	1 RS-485 (Half duplex, HIKVISION)
	Wiegand	1 Wiegand(Hik 26bit,Hik 34bit)
	USB	1
<b>Capacity</b>	Face capacity	1,500
	Card capacity	3,000
	Event capacity	150,000
<b>Authenticatio n</b>	Face recognition distance	0.3 to 1.5 m
	Face recognition accuracy rate	> 99%
	Face recognition duration	< 0.2 s
	Card type	EM card
	Card reading frequency	125 KHz
	Card reading distance	0 to 3 cm (Normal Card); 0 to 2 cm (Card with Different Shapes)
	Card reading duration	< 1 s
	<b>General</b>	Supplement light
Power supply		12 VDC, 1 A (power adapter included)
Working temperature		-30 °C to 60 °C (-22 °F to 140 °F)
Working humidity		0 to 90% (No condensing)
Protective level		IP65
Dimensions		91.3 mm × 181.3 mm × 24.5 mm (3.59" × 7.14" × 0.96")
Installation		Wall mounting
Weight		Gross weight: 0.93 kg (2.05 lb) Net weight: 0.36 kg (0.79 lb)
Language		English, Spanish (South America), Arabic, Thai, Indonesian, Russian, Vietnamese, Brazilian Portuguese, Japanese, Korean, Chinese Traditional, French, Turkish, Kazakh and Uzbek.
Platform		Hik-ProConnect and HikCentral Professional
<b>Function</b>	Live view	Support
	Two-way audio	Support
	Multi-factor authentication	Support
	Face	Support



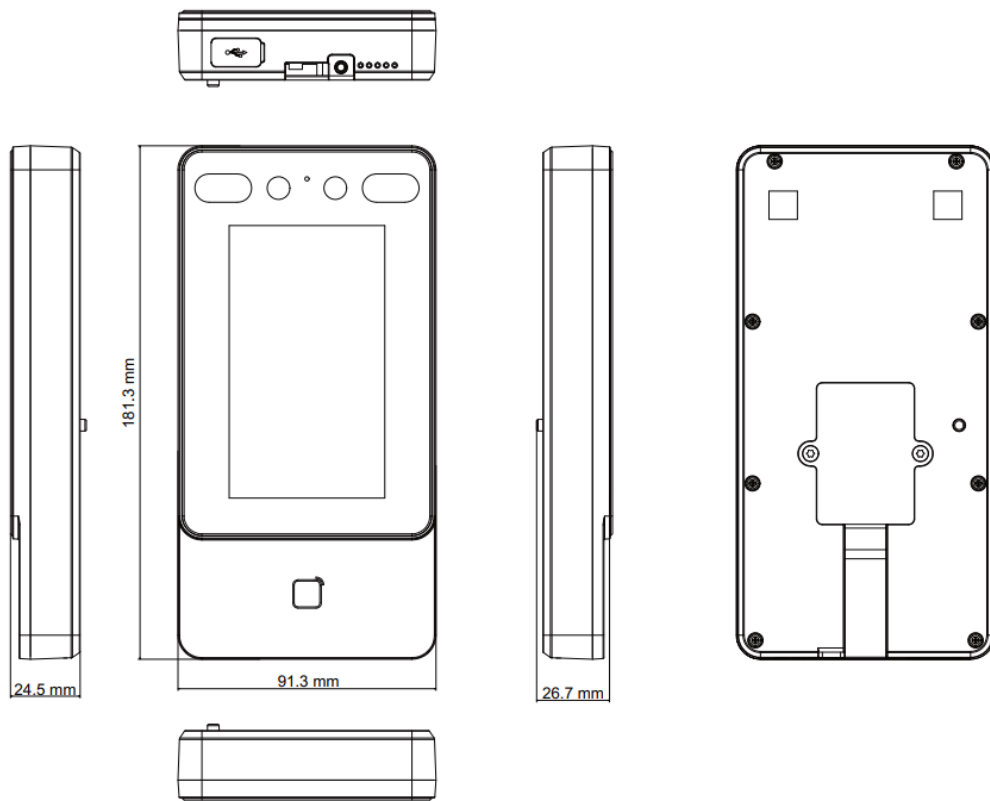

	anti-spoofing	
	First person in	Support
	Audio prompt	Support
	Time synchronization	Support

▪ **Dimension**



▪ **Accessory**

▪ **Optional**

DS-KAB6-ZU3 Brackets for face terminals	DS-KAB34X-S1 Protective Shield	DS-KAB6-W1 Bracket	DS-KAB671-P2 Stand Stick	DS-KAB6-ZU1 Brackets for face terminals
				

# See Far, Go Further



[www.hikvision.com](http://www.hikvision.com)  
[support@hikvision.com](mailto:support@hikvision.com)

