

DS-2CE79H0T-IT3ZE(C)
5 MP PoC Motorized Varifocal Turret Camera



- High quality imaging with 5 MP, 2560 × 1944 resolution
- 2.7 mm to 13.5 mm motorized varifocal lens
- Up to 40 m IR distance for bright night imaging
- Water and dust resistant (IP67)

▪ Specification

Camera	
Image Sensor	5 MP CMOS
Signal System	PAL/NTSC
Max. Resolution	2560 (H) × 1944 (V)
Frame Rate	5 M @ 20 fps, 4 M @ 30 fps, 4 M @ 25 fps, 1080p @ 30 fps, 1080p @ 25 fps
Min. Illumination	0.01 Lux @ (F1.6, AGC ON), 0 Lux with IR
Shutter Time	PAL: 1/25 s to 1/50,000 s; NTSC: 1/30 s to 1/50,000 s
Lens Mount	Φ14
Day & Night	IR Cut Filter
Angle Adjustment	Pan: 0° to 360°, Tilt: 0° to 75°, Rotation: 0° to 360°
Lens	
Lens Type	2.7 mm to 13.5 mm motorized varifocal lens
Focal Length & FOV	horizontal FOV: 95° to 26°, vertical FOV: 72° to 20°, diagonal FOV: 126° to 33°
Illuminator	
Supplement Light Range	IR: Up to 40 m
Image	
Day/Night Mode	Auto/Color/BW (Black and White)
Wide Dynamic Range (WDR)	Digital WDR
Image Parameters Switch	STD/HIGH-SAT
White Balance	Auto/Manual
Image Enhancement	DWDR, BLC, HLC, Global
Noise Reduction	2D DNR
Language	English
Image Settings	Brightness, Smart IR, Sharpness, AGC
Interface	
Video Output	1 HD analog output
General	
Power	12 VDC±15%/PoC.at, Max 8.4 W *You are recommended to use one power adapter for one camera, and use 2-pin power supply for long-distance power supply.
Operating Condition	-40 °C to 60 °C (-40 °F to 140 °F). Humidity 90% or less (non-condensing)
Material	Metal
Communication	HIKVISION-C
Dimension	123.87 mm × 110.24 mm × 134.3 mm (4.87" × 4.34" × 5.29")
Weight	Approx. 595 g (1.31 lb.)
Approval	
Protection	IP67

*5 MP PoC Motorized Varifocal Turret Camera

▪ Typical Application

Hikvision products are classified into three levels according to their anti-corrosion performance. Refer to the following description to choose for your using environment.

This model has MODERATE PROTECTION.

Level	Description
Top-level protection	Hikvision products at this level are equipped for use in areas where professional anti-corrosion protection is a





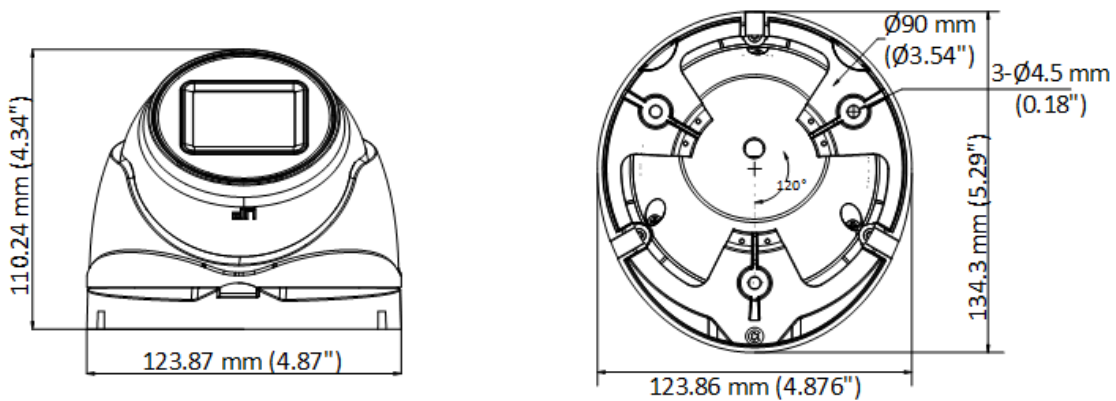

	must. Typical application scenarios include coastlines, docks, chemical plants, and more.
Moderate protection	Hikvision products at this level are equipped for use in areas with moderate anti-corrosion demands. Typical application scenarios include coastal areas about 2 kilometers (1.24 miles) away from coastlines, as well as areas affected by acid rain.
No specific protection	Hikvision products at this level are equipped for use in areas where no specific anti-corrosion protection is needed.

▪ **Dimension**



▪ **Accessory**

▪ **Optional**

DS-1280ZJ-TR12	DS-1280ZJ-M	DS-1275ZJ-SUS	DS-1276ZJ-SUS	DS-1281ZJ-M
				
DS-1273ZJ-130-TRL				
				

See Far, Go Further



www.hikvision.com
support@hikvision.com

