

**DS-2CD2121G0-I(W)(S)**

**2 MP WDR Fixed Dome Network Camera**



- High quality imaging with 2 MP resolution
- Efficient H.265+ compression technology
- Clear imaging against strong back light due to 120 dB true WDR technology
- Water and dust resistant (IP67) and vandal proof (IK10)
- Support up to 256 GB SD card storage

## ▪ Specification

Model		DS-2CD2121G0-I(W)(S)
Camera	Image Sensor	1/2.7" Progressive Scan CMOS
	Min. Illumination	Color: 0.005 Lux @ (F1.6, AGC ON), B/W: 0 Lux with IR
	Max. Resolution	1920 × 1080
	Shutter Time	1/3 s to 1/100,000 s
	Day & Night	IR Cut Filter
	Angle Adjustment	Pan: 0° to 355°, tilt: 0° to 75°, rotate: 0° to 355°
Lens	Focal Length & FOV	2.8 mm: horizontal FOV 111.6°, vertical FOV 59.1°, diagonal FOV 133.9° 4 mm: horizontal FOV 91.5°, vertical FOV 46.1°, diagonal FOV 109.8° 6 mm: horizontal FOV 56°, vertical FOV 29.8°, diagonal FOV 65.3°
	Lens Mount	M12
	Focus	Fixed
	Aperture	F1.6
Illuminator	Supplement Light Range	Up to 30 m
	IR Wavelength	850 nm
Video	Main Stream	50 Hz: 25 fps (1920 × 1080, 1280 × 720) 60 Hz: 30 fps (1920 × 1080, 1280 × 720)
	Sub-Stream	50 Hz: 25 fps (640 × 480, 640 × 360) 60 Hz: 30 fps (640 × 480, 640 × 360)
	Video Compression	Main stream: H.265+/H.265/H.264+/H.264 Sub-stream: H.265/H.264/MJPEG
	Video Bit Rate	32 Kbps to 8 Mbps
	H.264 Type	Baseline Profile/Main Profile/High Profile
	H.265 Type	Main Profile
	Region of Interest (ROI)	Support 1 fixed region for main stream
Network	Protocols	TCP/IP, ICMP, HTTP, HTTPS, FTP, DHCP, DNS, DDNS, RTP, RTSP, RTCP, PPPoE, NTP, UPnP™, SMTP, SNMP, IGMP, 802.1X, QoS, IPv6, Bonjour, IPv4, UDP, SSL/TLS
	Simultaneous Live View	Up to 6 channels
	API	Open Network Video Interface, ISAPI
	User/Host	Up to 32 users. 3 levels: administrator, operator and user
	Network Storage	Support Micro SD/SDHC/SDXC card (256 GB), local storage and NAS (NFS, SMB/CIFS), ANR
	Client	iVMS-4200, Hik-Connect, Hik-Central
	Web Browser	Plug-in required live view: IE 10+ Plug-in free live view: Chrome 57.0+, Firefox 52.0+ Local service: Chrome 57.0+, Firefox 52.0+
Image	Image Settings	Rotate mode, saturation, brightness, contrast, sharpness and white balance adjustable by client software or web browser

	Day/Night Switch	Day, Night, Auto, Schedule
	Image Enhancement	BLC, 3D DNR
	Wide Dynamic Range (WDR)	120 dB
<b>Interface</b>	Ethernet Interface	1 RJ45 10 M/100 M self-adaptive Ethernet port
	On-Board Storage	Built-in Micro SD slot, up to 256 GB
	Audio	-S: 1 input (line in), 1 output (line out)
	Alarm	-S: 1 input, 1 output (max. 12 VDC, 30 mA)
	Reset Key	Yes
<b>Event</b>	Basic Event	Motion detection, video tampering alarm
	Smart Event	Line crossing detection, intrusion detection
	Linkage	Upload to FTP/NAS/memory card, notify surveillance center, send email, trigger recording, trigger capture
<b>General</b>	Power	12 VDC $\pm$ 25%, 0.4 A, max. 5 W, $\varnothing$ 5.5 mm coaxial power plug PoE: 802.3af, Class 3, 36 V to 57 V, 0.20 A to 0.15 A, max. 6.5 W
	Dimension	$\varnothing$ 110.8 mm $\times$ 84.7 mm ( $\varnothing$ 4.4" $\times$ 3.3")
	Package Dimension	135 mm $\times$ 135 mm $\times$ 110 mm (5.3" $\times$ 5.3" $\times$ 4.3")
	Weight	Approx. 497 g (1.1 lb.)
	With Package Weight	Approx. 597 g (1.3 lb.)
	Startup and Operating Conditions	-30 °C to 60 °C (-22 °F to 140 °F). Humidity: 95% or less (non-condensing)
	Storage Conditions	-30 °C to 60 °C (-22 °F to 140 °F). Humidity: 95% or less (non-condensing)
	Language	33 languages English, Russian, Estonian, Bulgarian, Hungarian, Greek, German, Italian, Czech, Slovak, French, Polish, Dutch, Portuguese, Spanish, Romanian, Danish, Swedish, Norwegian, Finnish, Croatian, Slovenian, Serbian, Turkish, Korean, Traditional Chinese, Thai, Vietnamese, Japanese, Latvian, Lithuanian, Portuguese (Brazil), Ukrainian
	General Function	One-key reset, anti-flicker, heartbeat, mirror, password protection, privacy mask, watermark, IP address filter
<b>Approval</b>	EMC	FCC (47 CFR Part 15, Subpart B) CE-EMC (EN 55032:2015, EN 61000-3-2:2019, EN 61000-3-3:2013+A1:2019, EN 50130-4:2011+A1:2014) RCM (AS/NZS CISPR 32:2015) IC (ICES-003: Issue 7) KC (KN32:2015, KN35:2015)
	Safety	UL (UL 62368-1) CB (IEC 62368-1:2014+A11) CE-LVD (EN 62368-1:2014/A11:2017)

		LOA (IEC/EN 60950-1) BIS (IS 13252 (Part 1): 2010/IEC 60950-1: 2005)
	Environment	CE-RoHS (2011/65/EU); WEEE (2012/19/EU); Reach (Regulation (EC) No 1907/2006)
	Protection	IP67 (IEC 60529-2013) IK10 (IEC 62262:2002)



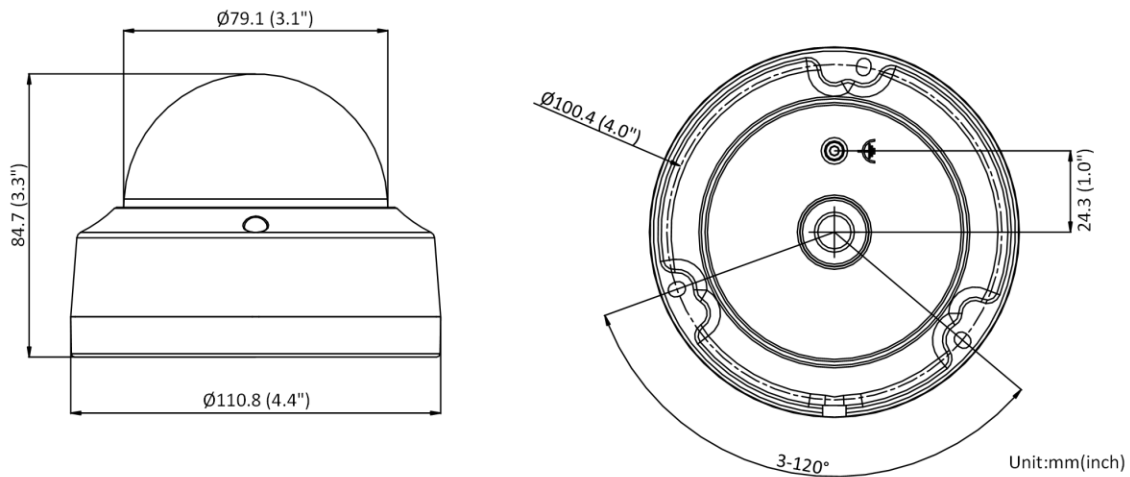











▪ **Dimension**

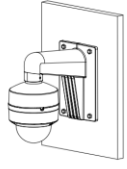

▪ **Accessory**

▪ **Optional**

DS-1275ZJ-S-SUS Vertical pole mount	DS-1275ZJ-SUS Vertical pole mount	DS-1280ZJ-DM18 Junction box	DS-1276ZJ-SUS Corner mount	DS-1272ZJ-110 Wall mount
<b>DS-1272ZJ-110B</b> Wall mount	<b>DS-220AZJ-145-WA</b> Wall mount	<b>DS-1258ZJ</b> Wall mount	<b>DS-1271ZJ-110</b> Pendant Mount	<b>DS-1250ZJ</b> Water-proof

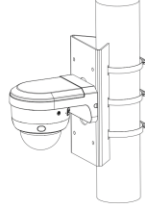
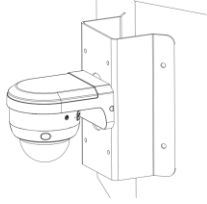
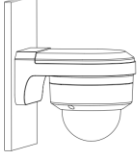
				
				
<b>DS-1259ZJ</b> <b>Inclined ceiling</b> <b>mount</b>	<b>DS-1475ZJ-SUS</b> <b>Vertical pole mount</b>	<b>DS-1476ZJ-SUS</b> <b>Corner mount</b>	<b>DS-220AZJ-130-WA</b> <b>Wall mount</b>	
				
				

# See Far, Go Further



[www.hikvision.com](http://www.hikvision.com)  
[support@hikvision.com](mailto:support@hikvision.com)

